

Variable Gradient Generators

for zonal centrifugation and column chromatography

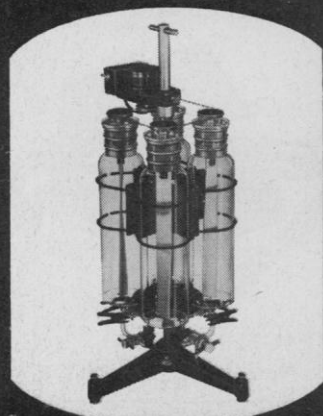

ZONAL and RECTANGULAR

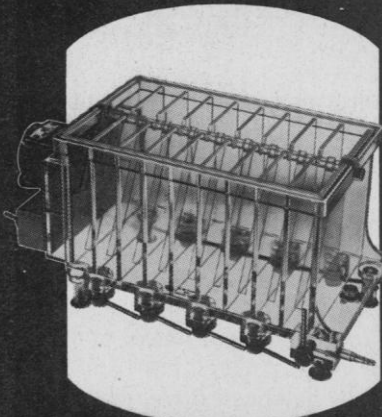

Generate reproducible linear or exponential gradients in one to four liter capacity. Choice of all-glass and Teflon models as well as acrylic plastic for aqueous solutions.

BUCHLER INSTRUMENTS DIV. NUCLEAR-CHICAGO CORP.

A SUBSIDIARY OF G. D. SEARLE & CO.

1327 SIXTEENTH ST., FORT LEE, N. J. 07024

Write for Technical Bulletins

Circle No. 88 on Readers' Service Card

obtained by 69 investigating physicians in West Germany. Of 1356 patients treated, 78 percent had leg ulcers. In children, burns were the most frequent indication. In 20 percent of the patients, the enzyme took effect within 3 days, in 97 percent within 14 days. Overall, a satisfactory result was obtained in 80 percent of all patients. Walter Zimmermann (University of Freiburg, Germany) reported that, in almost 400 burn cases, not a single keloid was formed and none of the wounds contracted in contrast to the relatively high incidence of both with other treatments. The various presentations conveyed the general impression that, after some 20 years of animal and clinical experimentation, a valuable addition to the armamentarium of topical drugs available for ambulatory and institutionalized patients had emerged.

INES MANDL

Columbia University,
College of Physicians & Surgeons,
New York 10032

Forthcoming Events

October

20-23. American Vacuum Soc., 7th annual, Washington, D.C. (Miss D. M. Hoffman, RCA Labs., David Sarnoff Research Center, Princeton, N.J. 08540)

21-23. Society of Mining Engineers of the American Inst. of Mining, St. Louis, Mo. (J. C. Fox, 345 E. 47 St., New York 10017)

21-23. Planetarium Teachers, East Lansing, Mich. (V. D. Chamberlain, Michigan State Univ., Talbert and Leota Abrams Planetarium, East Lansing)

21-23. Ultrasonic Symp. (G-SU), San Francisco, Calif. (W. J. Spencer, Bell Telephone Labs., Allentown, Pa. 18103)

21-24. National Assoc. of Biology Teachers, Denver, Colo. (J. P. Lightner, NABT, 1420 N St., NW, Washington, D.C. 20005)

21-24. Society of Photographic Scientists and Engineers, Washington, D.C. (H. J. Hall, 10 Maguire Rd., Lexington, Mass. 02173)

22-23. National Acad. of Engineering, Washington, D.C. (National Acad. of Engineering, Editorial Office, 2101 Constitution Ave., NW, Washington, D.C. 20418)

22-24. American Soc. for Aesthetics, Boulder, Colo. (J. R. Johnson, ASA, 1150 East Blvd., Cleveland, Ohio 44106)

22-24. Gerontological Soc., 23rd annual, Toronto, Ont., Canada. (E. Kaskowitz, GS, 660 S. Euclid, St. Louis, Mo. 63110)

23-24. Biological Sonar and Diving Mammals, 7th annual conf., Menlo Park, Calif. (T. C. Poulter, Biological Sonar Lab., Stanford Research Inst., Menlo Park 94025)

25-28. National Lubricating Grease Inst., 38th, Atlanta, Ga. (C. V. Pickell,

only from TechniLab

Thermajust

Immersion Heaters

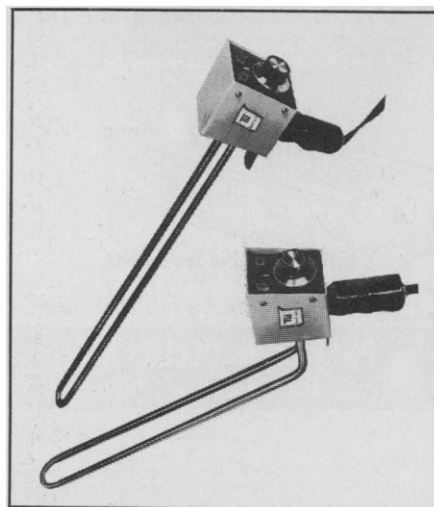

The TechniLab Thermajust immersion heater is a completely self-contained, precision made unit with built-in adjustable thermostatic control. Available in a wide range of tank and tray models, they maintain liquid temperatures to within ± 1 degree F. of dial setting.

FEATURES:

- Type 316 acid-resistant stainless steel heating element.
- Continuously adjustable time-proportional thermostat switch.
- Portable—with hanging clip and thermoplastic cool handle.
- Automatic time-proportional current regulation eliminates temperature override.
- Two pilot lights—one shows regulation cycle, the other one shows on-off condition of unit, a safety feature.
- Control dial with Hi-Low-Med & Off marks.
- 6 ft. heavy duty UL approved cord and 3 prong plug with adapter.
- 115 volt AC-DC.

At your nearest laboratory supply house.

Send for our NEW 84 page catalog 970.
For your FREE copy write Dept. E-9

TECHNILAB INSTRUMENTS, INC.

Subsidiary of Bel-Art Products

PEQUANNOCK, N. J. 07440

Circle No. 79 on Readers' Service Card

4635 Wyandotte St., Kansas City, Mo. 64112)

25-29. Institute of **Sanitation Management**, Cleveland, Ohio. (H. C. Rowe, 1710 Drew St., Clearwater, Fla. 33515)

25-30. American College of **Chest Physicians**, Los Angeles, Calif. (A. Soffer, ACCP, 112 E. Chestnut St., Chicago, Ill. 60611)

25-30. International Congr. of **Internal Medicine**, 11th, New Delhi, India. (H. Ludwig, Burgerspital, Basel, Switzerland)

26-27. Interagency **Chemical Rocket Propulsion** Group, Pasadena, Calif. (A. Broido, Pacific Southwest Forest and Range Experiment Sta., U.S. Forest Service, Box 245, Berkeley, Calif. 94701)

26-28. **Electronic and Aerospace Systems**, Washington, D.C. (R. A. Stampfl, Natl. Aeronautics and Space Administration, Washington, D.C.)

26-28. **Spectroscopy**, 17th symp. and exhibition of instrumentation, 17th, Ottawa, Ont., Canada. (J. L. Dalton, 555 Booth St., Ottawa 4)

26-29. **Instrument Soc. of America**, Philadelphia, Pa. (H. S. Kindler, ISA, 530 William Penn Pl., Pittsburgh, Pa. 15219)

26-30. Symposium on the Use of **Nuclear Techniques in the Measurement and Control of Environmental Pollution**, Salzburg, Austria. (J. H. Kane, Div. of Technical Information, U.S. Atomic Energy Commission, Washington, D.C. 20545)

26-30. American College of **Preventive Medicine**, Houston, Tex. (E. A. Piszcek, 6410 N. Leona Ave., Chicago, Ill. 60646)

26-30. American **Public Health Assoc.**, 98th, Houston, Tex. (B. F. Mattison, 1740 Broadway Ave., New York 10019)

26-30. American **Water Resources Conf.**, 6th, Austin, Tex. (W. S. Butcher, Civil Engineering Dept., Univ. of Texas, Austin 78712)

27-28. Society of **Plastics Engineers**, Cherry Hill, N.J. (A. E. Whitney, Jr., 31 Alexander Ave., Nutley, N.J.)

27-29. Western **Space Congr.**, 1st, Santa Maria, Calif. (C. E. Ewing, P.O. 1134, Santa Maria 93454)

27-31. Congress of **Neurological Surgeons**, Inc., 20th, St. Louis, Mo. (J. M. Thompson, 1955 Blossom Way, St. Petersburg, Fla. 33712)

28-30. **Electron Devices**, Washington, D.C. (Inst. of Electrical and Electronics Engineers, Electron Devices Group, 345 E. 47 St., New York 10017)

28-30. **Meteoritical Soc.**, Skyland, Va. (L. S. Walter, Planetology Branch, Code 644, NASA/Goddard Space Flight Center, Greenbelt, Md.)

28-30. **Operations Research Soc. of America**, Detroit, Mich. (R. M. Oliver, Dept. of Industrial Engineering, Univ. of California, Berkeley 94720)

28-30. **Planetology and Space Mission Planning**, 3rd conf., New York, N.Y. (R. D. Enzmann, Raytheon Corp., Bedford, Mass.)

28-31. American Assoc. of **Medical Assistants**, 14th annual, Des Moines, Iowa. (AAMA, Inc., 200 E. Ohio St., Chicago, Ill. 60611)

28-1. Federation of Societies for **Paint Technology**, 48th annual, Boston, Mass. (R. W. Matlack, 121 S. Broad St., Philadelphia, Pa. 19107)

29-30. Joint **Engineering Management**

Circle No. 29 on Readers' Service Card →

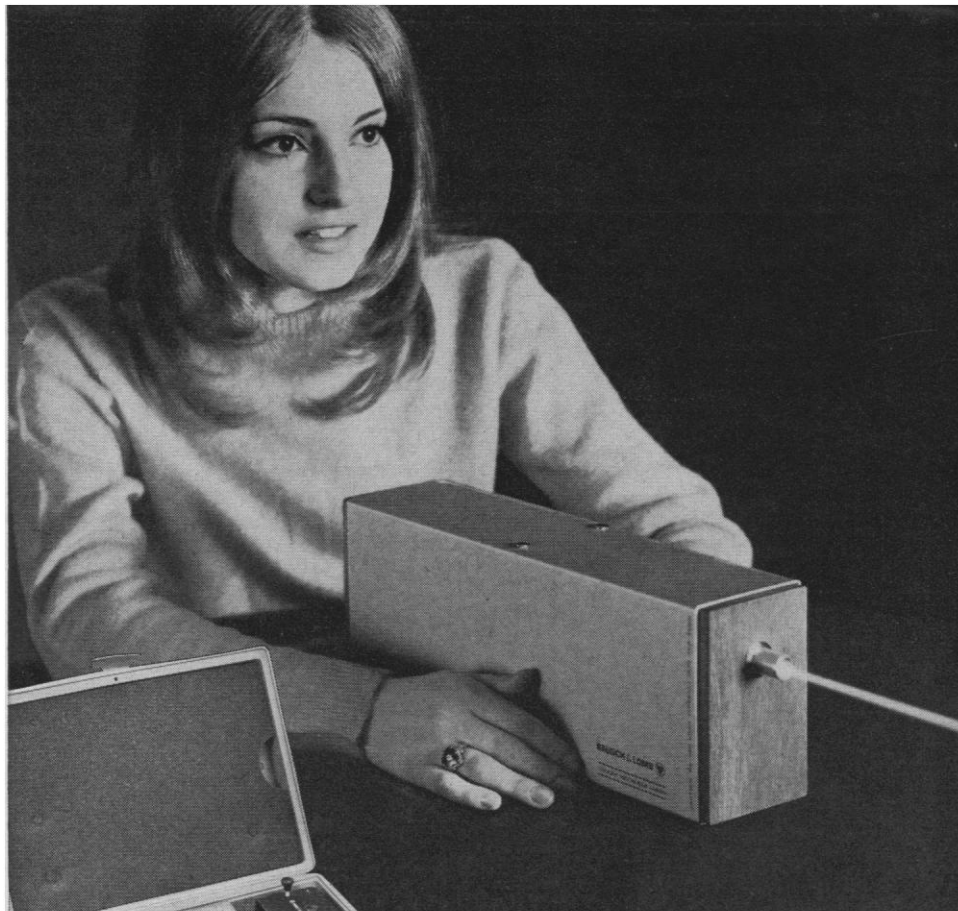

Teach light properties this modern laser way... for less than \$250!

With Bausch & Lomb's low cost helium-neon gas Laser and Laser Experiment Kit you will teach optical principles most effectually. Furthermore, you'll find your students cooperating most energetically.

Operation of the Laser is uncomplicated and dependable for classroom use. Just plug it in and it begins to lase. Power is .1mw, multi-mode, producing a monochromatic beam at 6328 Angstroms. It's about the size of a shoebox and weighs approximately three pounds.

The Experiment Kit contains all necessary components to conduct impressive demonstrations. There are set-ups for 13 experiments from reflection to a Michelson Interferometer. Even for making and reconstructing holograms. A comprehensive manual and treatise on laser theory and practice are included.

Just write for our catalog 41-2325 and you will have all the facts on this contemporary teaching tool.

BAUSCH & LOMB

SCIENTIFIC INSTRUMENT DIVISION

75933 Bausch Street, Rochester, New York 14602

New for NMR: 100.0% D₂O

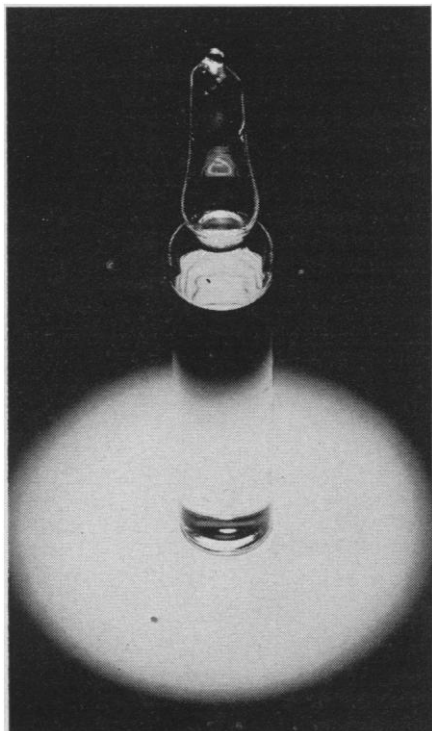

BIO-RAD now offers 100.0 mole percent deuterium oxide for use with all nuclear magnetic resonance instruments. This new 100.0% D₂O will produce straighter baselines, particularly in sensitive instruments with high signal-to-noise ratios. And there's no interference with the proton assay capability of the instrument, because the proton content of this new solvent is insignificant. This is demonstrated clearly in the NMR spectra below. The top tracing shows the proton peak of regular 99.8% D₂O. The bottom tracing, with a proton peak only barely visible, is the new 100.0% D₂O.

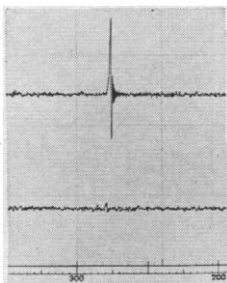

BIO-RAD supplies 100.0% D₂O in sealed 10 and 25 gram ampoules to be opened immediately before use. BIO-RAD also supplies 99.8% deuterium oxide at the lowest prices obtainable anywhere and a Biological Purity Grade for biochemical use. Your inquiry will bring full details on all three.

BIO-RAD Laboratories

32nd & Griffin Avenue
Richmond, CA 94804
Phone (415) 234-4130

Circle No. 82 on Readers' Service Card

1240

Conf., 18th annual, Chicago, Ill. (G. J. Lukas, Keebler Co., 677 Lank Ave., Elmhurst, Ill. 60126)

29-2. Association of American Medical Colleges, 9th annual, Los Angeles, Calif. (D. E. Mattson, Div. of Educational Measurement and Research, AAMC, 2530 Ridge Ave., Evanston, Ill. 60201)

30-1. International Soc. of Fire Service Instructors, Clearwater, Fla. (B. Miles, Fire Administration Dept., St. Petersburg, Fla.)

November

1-4. American Soc. for Horticultural Science, Miami Beach, Fla. (C. Blackwell, 615 Elm St., St. Joseph, Mich. 49085)

1-4. American Soc. of Tropical Medicine and Hygiene, San Francisco, Calif. (M. M. Brooke, P.O. Box 15208, Emory Univ., Atlanta, Ga. 30333)

1-6. American Assoc. of Medical Record Librarians, Colorado Springs, Colo. (M. J. Waterstraat, 211 E. Chicago Ave., Chicago, Ill. 60611)

2-4. Automated Analysis, New York, N.Y. (N. B. Scova, Technicon Corp., Tarrytown, N.Y. 10591)

2-4. Society of Engineering Science, Inc., 8th annual, Washington, D.C. (N. W. Singpurwalla, School of Engineering and Applied Sciences, George Washington Univ., Washington, D.C. 20006)

2-6. American Assoc. for Laboratory Animal Science, 21st annual, Chicago, Ill. (T. W. Harris, AALAS, 4 E. Clinton St., P.O. Box 10, Joliet, Ill. 60434)

2-6. American Concrete Inst., St. Louis, Mo. (R. E. Wilde, Box 4754, Bedford Sta., Detroit, Mich. 48219)

2-6. Electric Contact Phenomena, Chicago, Ill. (R. E. Armington, Electrical Engineering Dept., Illinois Inst. of Technology, Chicago 60616)

2-11. Reliability Engineering and Management Inst., 8th annual, Tucson, Ariz. (D. Kececioglu, Aerospace and Mechanical Engineering Dept., Univ. of Arizona, Tucson 85721)

3-5. Conference on Cold Forming of Metal Parts, Detroit, Mich. (R. C. Rittenhouse, American Soc. of Metals, Metals Park, Ohio 44073)

3-6. Acoustical Soc. of America, Houston, Tex. (B. H. Goodfriend, ASA, 335 E. 45 St., New York 10017)

3-6. Basic Science and Nuclear Divisions, joint fall mtg., Gatlinburg, Tenn. (W. R. Jacoby, Nuclear Div., Westinghouse Electric Corp., P.O. Box 217, Cheswick, Pa. 15024)

3-6. Health Physics Soc., 5th annual, Idaho Falls, Idaho. (C. A. Pelletier, P.O. Box 2108, Idaho Falls 83401)

3-7. Technical Assoc. of the Pulp and Paper Industry, 24th annual, New Orleans, La. (M. A. Burnston, 360 Lexington Ave., New York 10017)

4-5. American Assoc. for the Study of Liver Diseases, Chicago, Ill. (F. Schaffner, Mount Sinai School of Medicine, Fifth Ave. and 100th St., New York 10029)

4-6. Diffraction Conf., 28th, Pittsburgh, Pa. (E. McGandy, Dept. of Biochemistry and Nutrition, Univ. of Pittsburgh, Pittsburgh 15213)

4-6. Fuels and Lubricants and Transportation, Society of Automotive Engineers, Philadelphia, Pa. (W. I. Marble,

SAE, 345 E. 47 St., New York 10017)

4-6. Nuclear Symp. on Nuclear Instrumentation for Research and Development, New York, N.Y. [W. W. Managan, Argonne Natl. Lab. (D818), 9700 S. Cass Ave., Argonne, Ill. 60439]

4-6. American Assoc. of Textile Chemists and Colorists, Atlanta, Ga. (G. P. Paine, Box 12215, Research Triangle Park, N.C. 27709)

4-7. American Soc. of Cytology, 18th annual, Los Angeles, Calif. (W. R. Lang, 7112 Lincoln Drive, Philadelphia, Pa. 19119)

4-7. Medical Soc. of the United States and Mexico, 18th annual, Jalisco, Mexico. (V. E. Bryant, 333 W. Thomas Rd. No. 207, Phoenix, Ariz. 85013)

4-7. Symposium on Nuclear Science, New York, N.Y. (M. E. Cassidy, U.S. Atomic Energy Commission, 376 Hudson St., New York 10014)

4-7. Plasma Physics, Washington, D.C. (R. M. Sinclair, Physics Section, Natl. Science Foundation, Washington, D.C. 20550)

4-8. American Soc. of Clinical Hypnosis, Miami Beach, Fla. (W. T. Heron, 1500 NW 43rd Terrace, Park South, Fort Lauderdale, Fla. 33313)

4-8. American Assoc. of Psychiatric Clinics for Children, 22nd annual, Philadelphia, Pa. (J. L. Friend, AAPPCC, 250 W. 57 St., New York 10019)

5-7. Symposium on Nutritional and Environmental Problems of the Inner City, Nashville, Tenn. (H. A. Moses, Meharry Medical College, Nashville 37208)

5-8. Association of Clinical Scientists, Washington, D.C. (F. W. Sunderman, Jr., Univ. of Connecticut Medical School, 2 Holcomb St., Hartford 06112)

5-8. Italian Soc. of Urology, 43rd congr., Florence, Italy. (M. Rizzo, Istituto di Urologia Università degli Studi di Firenze, Firenze)

6-7. Central Soc. for Clinical Research, Chicago, Ill. (J. W. Eckstein, Dept. of Internal Medicine, Univ. of Iowa Hospitals, Iowa City 52240)

6-7. National Conf. on Management of Occlusive Arterial Disease, Nashville, Tenn. (W. A. Dale, 2010 Church St., Nashville 37203)

6-10. National Biological Congr., Detroit, Mich. (J. R. Olive, American Inst. of Biological Sciences, 3900 Wisconsin Ave., NW, Washington, D.C. 20016)

6-11. American Soc. of Hospital Pharmacists, Los Angeles, Calif. (J. A. Oddis, ASHP, 4630 Montgomery Ave., Bethesda, Md. 20014)

7-8. American College of Dentists, Las Vegas, Nev. (R. J. Nelsen, 4236 Lindell Blvd., St. Louis, Mo. 63108)

7-10. American Medical Women's Assoc., San Juan, Puerto Rico. (G. Conroy, AMWA, 1740 Broadway, New York 10019)

8-12. American Dental Assoc., Las Vegas, Nev. (C. G. Watson, ADA, 211 E. Chicago Ave., Chicago, Ill. 60611)

8-12. Society of Exploration Geophysicists, New Orleans, La. (H. Breck, P.O. Box 3098, Tulsa, Okla. 74101)

9-11. Cyclic 3',5' AMP and Cell Function, New York, N.Y. (G. A. Robison, Vanderbilt Univ., Nashville, Tenn.)

10-12. Society of Plastics Engineers,

Signal Averaging... Principles and Practices NMR Fourier Spectroscopy

Number 7 of a Series

In Number 3 of this series we discussed how and why Fourier transform techniques are used in infrared spectroscopy and said that the same principles could be extended to Nuclear Magnetic Resonance (NMR) spectroscopy. We recently applied our 1070 System to a Bruker Scientific, Inc. (Elmsford, N.Y.) spec-

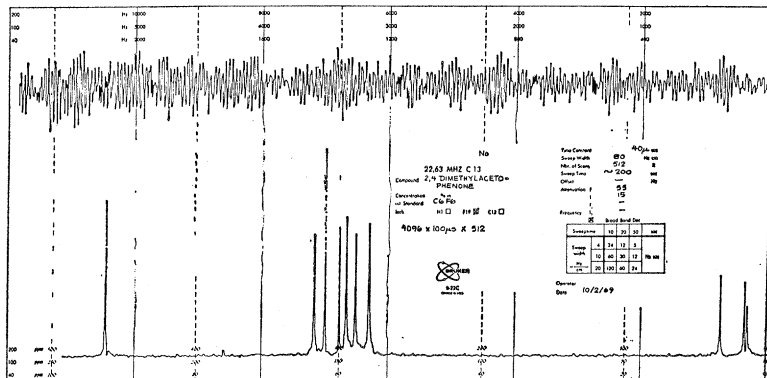

trometer and the above ^{13}C interferogram and spectrum are early results of this joint effort. The interferogram is only the first 1024 data points of a 4096 point free induction signal and is the average of 512 sweeps taking a total of approximately 200 seconds to accumulate. The Fourier transformed high resolution spectrum is shown below it. The equivalent sweep width is 5 KHz.

The significance of this technique lies in the time savings that can be achieved and the fact that this time savings can be put to good use in improving sensitivity or signal-to-noise ratio. The above spectrum of naturally low abundance ^{13}C , if recorded by conventional (CW) NMR techniques, would have taken 10 to 12 hours instead of 3 to 4 minutes.

While these data demonstrate approximately a 200:1 time savings, much longer savings are theoretically possible. Ernst and Anderson¹ have shown that the theoretical time reduction increases in proportion to the spectral resolution. The relaxation times (T_1) of the nuclear spin systems have been considered a limiting factor in approaching these theoretical values. However, recent experiments² indicate that the T_1 limitation can be overcome by newly developed techniques and that savings in the order of 10,000:1 may soon be practical. If part of these time savings were used for sensitivity improvement through signal averaging, signal-to-noise ratio improvements of one to two orders of magnitude could be achieved.

Interested? Why not call or write to arrange to see a Fabri-Tek 1070 System.

References:

1. R. R. Ernst and W. A. Anderson, *Rev. Sci. Instr.*, Vol. 37, 93 (1966).
2. E. D. Becker, J. A. Ferretti, and T. C. Farrar, *J. Am. Chem. Soc.* Vol. 91, 27 (1969).

FABRI-TEK INSTRUMENTS, INC.

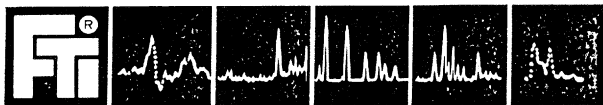

5225 VERONA ROAD • MADISON, WIS. 53711 • PHONE: 608/271-3333

Sales and Service: In Canada by Ahearn & Soper, Limited, 844 Caledonia Road, Toronto 19, Ont. Tel. (416) 789-4325 — Telex 02-2757. Branches in Montreal, Vancouver, and Ottawa . . . In Europe by Fabri-Tek Instruments, Inc., 6000 Frankfurt 1, Eschersheimer Landstr. 34, West Germany

Circle No. 26 on Readers' Service Card

2nd technical conf., St. Louis, Mo. (J. H. Hyden, SPE, 656 W. Putnam Ave., Greenwich, Conn. 06830)

11-12. **Sex and Gender Deviations in Children**, Columbia, Mo. (Office of Continuing Medical Education, Univ. of Missouri School of Medicine, 175 Medical Center, Columbia 65201)

11-13. **Geological Soc. of America**, 83rd annual, Milwaukee, Wis. (L. M. Cline, GSA, P.O. Box 1719, Boulder, Colo. 80302)

11-13. **National Assoc. of Geology Teachers**, Milwaukee, Wis. (M. B. Rosalsky, Dept. of Geology, City College of New York, Convent Ave. at 138th St., New York 10031)

11-13. **Paleontological Soc.**, Milwaukee, Wis. (R. L. Langenheim, Dept. of Geology, Univ. of Illinois, Urbana 61801)

11-14. **Seismological Soc. of America**, Milwaukee, Wis. (D. Tocher, P.O. Box 826, Berkeley, Calif. 94701)

12-13. **Canadian Symp. on Communications**, Montreal, P.Q. (M. L. Blostein, Electrical Engineering Dept., McGill Univ., Montreal 110)

12-13. **Immunoglobulins**, Philadelphia, Pa. (H. M. Rawsley, William Pepper Lab., Dept. of Pathology, Univ. of Pennsylvania, Philadelphia)

12-13. **Symposium on Man-Machine Systems**, Winter Park, Fla. (M. J. Kahn, AAI Corp., Cockeysville, Md. 21030)

12-15. **American Heart Assoc.**, 43rd annual scientific sessions, Atlantic City, N.J. (AHA, 44 E. 23 St., New York 10010)

12-15. **American Soc. of Therapeutic Radiologists**, Phoenix, Ariz. (C. R. Bogardus, 800 NE 13th St., Oklahoma City, Okla. 73104)

14-15. **Midwestern Conf. in Comparative Endocrinology**, Cincinnati, Ohio. (W. W. Leavitt, Dept. of Physiology, College of Medicine, Univ. of Cincinnati, Cincinnati 45219)

15-19. **Engineering in Medicine and Biology**, 23rd conf., Washington, D.C. (R. Johns, 522 Traylor Bldg., Johns Hopkins School of Medicine, Baltimore, Md. 21205)

15-19. **American Nuclear Soc.**, Washington, D.C. (J. Stouky, NUS Corp., 2351 Research Blvd., Rockville, Md. 20850)

16-17. **American Petroleum Inst.**, 50th annual, New York, N.Y. (H. A. Fondou, 1271 Avenue of the Americas, New York 10020)

16-18. **Chemical Marketing Research Assoc.**, San Francisco, Calif. (C. W. Slade, Jr., Chemical Marketing Research Assoc., 100 Church St., New York 10007)

16-19. **Society of Vertebrate Paleontology**, Toronto, Ont., Canada. (J. H. Ostrom, Yale Peabody Museum, 170 Whitney Ave., New Haven, Conn. 06520)

17-19. **Fall Joint Computer Conf.**, 7th annual, Houston, Tex. (B. Pollard, RCA-NPL, 200 Forest St., Marlboro, Mass. 01752)

17-20. **Magnetism and Magnetic Materials**, 16th annual conf., Miami Beach, Fla. (H. C. Wolfe, American Inst. of Physics, 335 E. 45 St., New York 10017)

17-22. **Pan American Medical Assoc.**, 45th, Hollywood Beach, Fla. (J. Eller, 745 Fifth Avenue, New York 10022)

18-20. **Eastern Analytical Symp.**, New York, N.Y. (D. A. Pragay, P.O. Box 38, Buffalo, N.Y. 14215)

18-20. **Hamster Pathology**, Boston, Mass. (F. Homburger, Bio-Research Inst., Inc., 9 Commercial Ave., Cambridge, Mass. 02141)

18-20. National Assoc. of **Police Labs.** and the Bureau of **Narcotics and Dangerous Drugs**, New York, N.Y. (Lt. F. Fernandez, Suffolk County Police Dept. Lab., Veteran's Highway, Hauppauge, N.Y. 11787)

19-20. American Assoc. for **Automotive Medicine**, Ann Arbor, Mich. (J. L. Weygandt, 716 Monroe St., Sheboygan Falls, Wis. 53085)

19-20. **Biomedical Materials**, London, England. (Meetings Officer, Inst. of Physics and The Physical Soc., 47 Belgrave Sq., London, S.W.1, England)

19-20. **Cancer Conf.**, Houston, Tex. (F. Goff, M. D. Anderson Hospital, Univ. of Texas, Houston)

19-20. Conflicts in **Water Resources Planning**, What are the Remedies?, Austin, Tex. (S. Ferguson, Center for Research in Water Resources, Balcones Research Center, Route 4, Box 189, Austin 78757)

19-22. American **Anthropological Assoc.**, San Diego, Calif. (E. J. Lehman, Executive Director, AAA, 1703 New Hampshire Ave., NW, Washington, D.C. 20009)

19-22. Society for **Psycho-physiological Research**, New Orleans, La. (L. H. Miller, Louisiana State Univ. Medical Center, 1542 Tulane Ave., New Orleans 70112)

20-21. Tennessee Acad. of **Science**, Memphis, Tenn. (J. D. Caponetti, Dept. of Botany, Univ. of Tennessee, Knoxville 37916)

20-23. American **Speech and Hearing Assoc.**, New York, N.Y. (K. O. Johnson, ASHA, 9030 Old Georgetown Rd., Washington, D.C. 20014)

21-24. Association of Schools of **Allied Health Professions**, 3rd annual, Chicago, Ill. (J. Von Bargen, Suite 300, 1 Dupont Circle, NW, Washington, D.C. 20036)

23-25. American Physical Soc., Div. of **Fluid Dynamics**, 23rd, Charlottesville, Va. (Y. H. Pao, Boeing Scientific Research Labs., P.O. Box 3981, Seattle, Wash. 98124)

26-28. Central Assoc. of **Science and Mathematics Teachers**, Chicago, Ill. (D. R. Winslow, P.O. Box 246, Bloomington, Ind. 47401)

26-29. National Council for **Geographic Education**, Detroit, Mich. (L. Mitchell, NCGE, 111 W. Washington St., Chicago, Ill. 60602)

29-30. International **Exchange of Technology**, Research Triangle Park, N.C. (G. R. Herbert, Research Triangle Inst., P.O. Box 12194, Research Triangle Park 27709)

29-3. American Inst. of **Chemical Engineers**, Chicago, Ill. (F. J. Van Antwerpen, AICE, 345 E. 47 St., New York 10017)

29-3. Association of **Military Surgeons** of the United States, Washington, D.C. (F. E. Wilson, AMSUS, 8502 Connecticut Ave., Chevy Chase, Md. 20015)

29-4. American Soc. of **Mechanical Engineers**, New York, N.Y. (A. B. Conlin, Jr., Technical Dept., ASME, 345 E. 47 St., New York 10017)

29-4. **Radiological Soc.** of North America, Chicago, Ill. (M. D. Frazer, RSNA,

Only Waring makes Blendors®

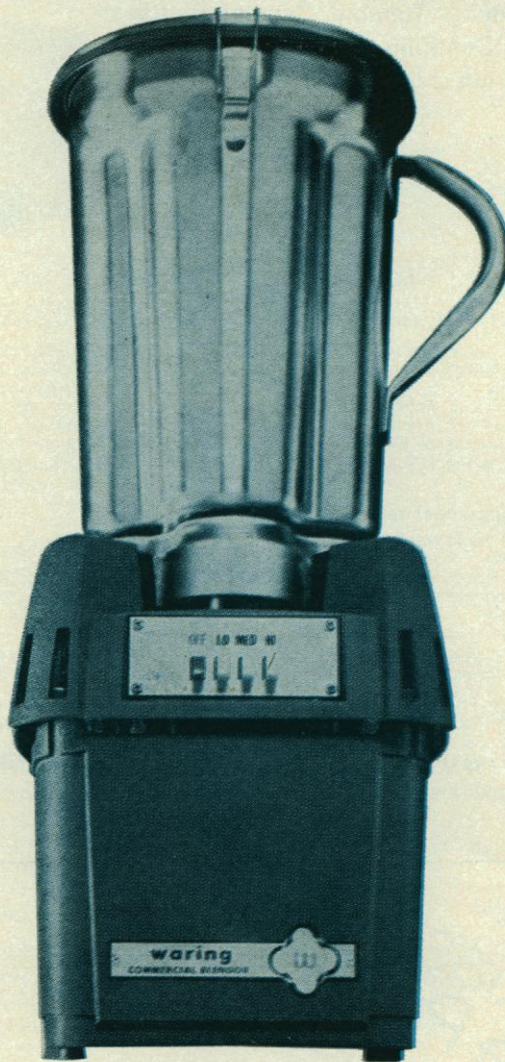

just for laboratories

... with the one-gallon Waring's exclusive cloverleaf shape, hydrodynamically designed for perfect blending action . . . with a solid one-piece cover plus molded gasket for a perfect seal . . . and with our 3-speed, 1725-watt motor — you can grind, emulsify, disintegrate, homogenize, shred, blend, or mix with power to spare, and in seconds!

Waring's one-gallon container, cover, and blending assembly are stainless steel, easy to clean and trouble free. There's a marvelous adapter that lets you use the smallest container on a one-gallon motor base.

There are explosion-proof models . . . one-quart models, some with timers, some with 7-speed controls . . . and accessories from 12 ml "Mini Containers" to ice crusher attachments. All are heavy duty construction and warranted for one year of commercial use.

Waring Blendors are unique — no wonder we copyrighted the name!

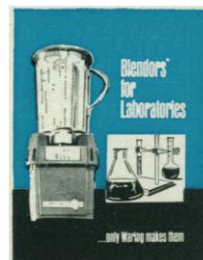

Write for our new catalog and see for yourself.

waring

Waring Products Division
Dynamics Corporation of America
New Hartford, Conn. 06057

AVCO LASERS

Dial-a-Line Tunable Wavelength Laser
Provides Continuous Tuning
From 360 nm to 650 nm



Dial-a-Line Laser Features

- Sealed cells, no cooling or flowing of dyes
- Simple, fast dye cell replacement without mirror changes
- Low operating and maintenance costs
- Laser pumped — no flashlamp replacement
- Warranted performance and life

For details, circle reader's service number 85.

A laser for micromachining

- Can produce slots less than 200 micro-inches in width
- Can machine most materials
- Pulsed operation, high repetition rates
- High peak power
- Near diffraction limited UV output
- Test facility available

For details, circle reader's service number 87.

Model C950 UV Laser

- UV output at 337.1 nm. Visible at 540.1 nm
- Pumps dyes efficiently and easily
- Pulsed operation, repetition rates up to 100 pps
- High peak power, 100 kW at 337.1 nm
- Stable operation
- Warranted performance and life
- Most reliable laser in its class

For details, circle reader's service number 86.

A laser for interferometry

- Visible output at 540.1 nm with enough energy to expose film in a single pulse
- Pulsed operation — 3 nanosecond pulse width
- 30 cm coherence length

For details, circle reader's service number 87.

Write today for complete details or call collect (617) 389-3000 and ask for Dick Neal.



EVERETT RESEARCH LABORATORY

2385 REVERE BEACH PARKWAY · EVERETT, MASSACHUSETTS 02149

Circle No. 85 on Readers' Service Card

Fight backlash with a Prior Micromanipulator.

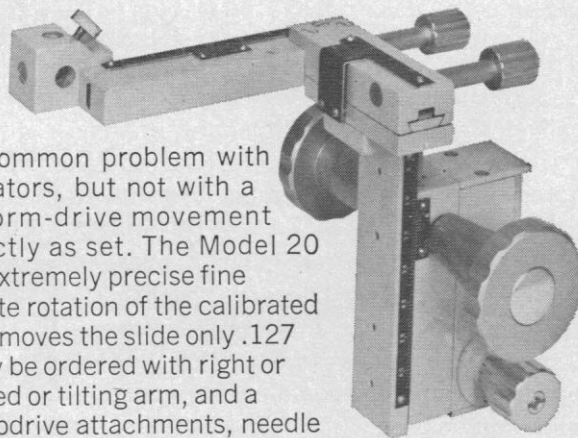

Backlash is a common problem with many micromanipulators, but not with a Prior. Its robust, worm-drive movement always remains exactly as set. The Model 20 shown here features extremely precise fine adjustment; a complete rotation of the calibrated fine adjustment knob moves the slide only .127 mm. The Prior 20 may be ordered with right or left-hand controls, fixed or tilting arm, and a variety of bases. Microdrive attachments, needle holders and other accessories are available.

Prior Micromanipulators are made in England, with much the same care and expert craftsmanship as goes into a Rolls-Royce. Every instrument is thoroughly tested and individually adjusted before delivery. For literature on the Prior 20, write: E. Sobotka Co. Inc., 110 Finn Court, Farmingdale, N.Y. 11735.

sobotka

Circle No. 83 on Readers' Service Card

1244

Inc., 713 E. Genesee St., Syracuse, N.Y. 13210)

30-2. Conference on the **Fatigue Problem**, Detroit, Mich. (J. A. Fellows, American Soc. for Metals, Metals Park, Ohio)

30-3. **Entomological Soc. of America**, Miami Beach, Fla. (W. P. Murdoch, 4603 Calvert Rd., College Park, Md. 20740)

30-4. **Engineering Materials and Design**, intern. exhibition and trade fair, London, England. (Industrial and Trade Fairs, Ltd., Commonwealth House, New Oxford St., London, W.C.1, England)

December

1-3. **Problems of Electroplating**, 3rd symp., Budapest, Hungary. (Scientific Soc. of Mechanical Engineers, Szabadsag Ter. 17, Budapest)

1-6. **Radiological Soc. of North America**, Chicago, Ill. (M. D. Frazier, 713 E. Genesee St., Syracuse, N.Y. 13210)

1-7. **International Hospital Federation**, 2nd, San Jose, Costa Rica. (J. Gonzalez, Pan American Office, 1 Farragut Sq., South, Washington, D.C. 20006)

1-8. **International Symp. on the Results of Research on Representative and Experimental Basins**, Wellington, New Zealand. (L. A. Heindl, Royal Soc. of New Zealand, P.O. Box 196, Wellington)

2-3. **Materials/Process Selection**, Phase II, Cleveland, Ohio. (J. A. Fellows, American Soc. for Metals, Metals Park, Ohio 44073)

2-4. **Vehicular Technology**, 21st conf., Washington, D.C. (P. M. Kelly, Kelly Scientific Corp., 3900 Wisconsin Ave., NW, Washington, D.C. 20016)

2-9. **Management of Emotional Problems in the Older Person**, New York, N.Y. (H. Gershman, American Inst. for Psychoanalysis, 329 E. 62 St., New York 10021)

3-4. Conference on **Clinical Pharmacology**, Washington, D.C. (L. I. Goldberg, Emory Univ. School of Medicine, Atlanta, Ga.)

4. American Assoc. of **Physicists in Medicine**, Chicago, Ill. (M. Rozenfeld, Argonne Hospital, 950 E. 59 St., Chicago 60637)

4-6. American Acad. of **Psychoanalysis**, New York, N.Y. (J. B. Miller, AAP, 510 E. 86 St., New York 10028)

5-10. American Acad. of **Dermatology**, Chicago, Ill. (F. A. J. Kingery, 2250 Northwest Flanders, Portland, Ore. 97201)

6. American Soc. of **Hospital Pharmacists**, 5th annual, Anaheim, Calif. (W. E. McConnell, Dept. of Education and Training, 4630 Montgomery Ave., Washington, D.C. 20014)

6-8. American Soc. of **Hematology**, San Juan, Puerto Rico. (F. H. Gardner, Presbyterian-Univ. of Pennsylvania Medical Center, Philadelphia 19104)

6-10. Association of **State and Territorial Health Officers**, Washington, D.C. (N. J. Swearingen, 128 C St., NE, Washington, D.C. 20002)

6-11. **International Clean Air Congr.**, 2nd, Washington, D.C. (A. Arch, Air Pollution Control Assoc., 4400 Fifth Ave., Pittsburgh, Pa. 15213)

6-11. Pan American Congr. of **Rheumatology**, 5th, Punta del Este, Uruguay. (H. Havranek, Hospital Maciel, Calle 25 de Mayo 174, Montevideo, Uruguay)

SCIENCE, VOL. 169