

Order your FREE Statham Transducer Catalog today!

Transducer catalog features model descriptions of all transducers and readout accessories as well as notes on industrial, research and scientific applications. Write to Tom Culhane, MS 216A Honeywell, Test Instruments Division, P.O. Box 5227, Denver, Colo. 80217.

Honeywell engineers
sell solutions

Honeywell

Circle No. 84 on Readers' Service Card

1494

along any of these dimensions, but could not categorize them with respect to shape or color. Humphrey's results harmonized with a report of C. Trevathan of Caltech (submitted to, but not read at, the conference) that human subjects with forebrain commissures transected were able to compare relative positions, velocities, sizes, or brightness values of objects presented within opposite hemifields, but that they could not match objects in terms of color or shape. Even among advanced primates the tectofugal system seems to process information about location, size, or movement of objects, whereas their identification as shapes or colors demands the cooperation of the geniculofugal system. Although most of the information presented at this conference was new, the participants were, on several occasions, gratified by the extent to which diverse pieces of evidence fell together into a cohesive picture of the vertebrate visual system.

This meeting was sponsored by a small grant from the National Institute of Mental Health (MH 17163). The proceedings will be published during 1970 as three issues of a new journal *Brain, Behavior and Evolution*; the three issues will be available to nonsubscribers as a single edition.

DAVID J. INGLE
Neuropsychology Laboratory, McLean Hospital, Belmont, Massachusetts

GERALD E. SCHNEIDER
Department of Psychology, Massachusetts Institute of Technology, Cambridge

Forthcoming Events

July

19-24. American Assoc. of **Clinical Chemists**, 22nd natl., Buffalo, N.Y. (D. A. Pragay, P.O. Box 38, Buffalo 14215)

20-22. American Inst. of **Aeronautics and Astronautics**, Detroit, Mich. (W. I. Marble, 2 Pennsylvania Plaza, New York 10001)

20-22. Society of **Automotive Engineers**, Detroit, Mich. (W. I. Marble, 2 Pennsylvania Plaza, New York 10001)

20-22. Conference on the **Fatigue Problem**, Boston, Mass. (J. A. Fellows, American Soc. for Metals, Metals Park, Ohio 44073)

20-22. Society of Mechanical Engineers **Reliability and Maintainability Conf.**, Detroit, Mich. (W. I. Marble, 2 Pennsylvania Plaza, New York 10001)

20-24. Association for the Study of **Animal Behavior**, Birmingham, England. (S. Dimond, Dept. of Psychology, University College, Cardiff, Wales)

20-24. Symposium on Coastal **Geodesy**, Munich, Germany. (G. W. Lennon,

Introducing . . .

23

IMPORTANT COENZYME A DERIVATIVES

produced by
P-L Biochemicals...
world leader in
Co-A and its ACYL
derivatives:

The newest of these are:

Acetoacetyl Coenzyme A
n-Butyryl Coenzyme A
Crotonyl Coenzyme A
Dephospho Coenzyme A
Formyl Coenzyme A
Glutaryl Coenzyme A
n-Heptanoyl Coenzyme A
n-Hexanoyl Coenzyme A
Isobutyryl Coenzyme A
Isovaleryl Coenzyme A
n-Octanoyl Coenzyme A
Oleoyl Coenzyme A
Oxidized Coenzyme A
n-Propionyl Coenzyme A
Stearoyl Coenzyme A
Succinyl Coenzyme A
Tiglyl Coenzyme A
n-Valeryl Coenzyme A
3-Hydroxy-3-Methylglutaryl
Coenzyme A



Write for our new Reference Catalog #102. It lists over 550 Nucleotides/Coenzymes, Enzymes, Lipids, Buffers and many others for LIFE SCIENCE RESEARCH.

excellence in  biochemistry

P-L Biochemicals, Inc./1037 West McKinley Ave./Milwaukee, Wis. 53205.
Tele. (414) 271-0667/Cable Address: P-L Biochem./Urgent Orders Call Collect.

Circle No. 86 on Readers' Service Card

SCIENCE, VOL. 168

Inst. of Coastal Oceanography and Tides, Bidston Observatory, Birkenhead, Cheshire, England)

20-24. **Reactions in Solution**, intern. conf., Kent, England. (G. R. Martin, Chemical Lab., Univ. of Kent at Canterbury, Canterbury, Kent)

20-24. **Urban Systems Engineering**, Henniker, N.H. (M. Wachs, Univ. of Illinois, Chicago)

21-23. Society for **Experimental Biology**, Dublin, Ireland. (A. P. M. Lockwood, Dept. of Oceanography, Univ. of Southampton, Southampton, England)

21-23. National Symp. on Data and Instrumentation for **Water Quality Management**, Madison, Wis. (I. Grossman, New York State Dept. of Health, Div. of Pure Waters, Albany 12208)

21-24. Conference on **Atomic Physics**, 2nd intern., Oxford, England. (E. K. Woodgate, Dept. of Physics, Clarendon Lab., Parks Rd., Oxford)

21-24. **Computer Science Symp.**, 2nd annual, Bangkok, Thailand. (L. Padunchewit, Computer Science Lab., Chulalongkorn Univ., Bangkok)

22-24. **Electronic Probe Analysis**, 5th natl. conf., New York, N.Y. (P. Lublin, Gen. Telephone & Electronics Lab., Bay-side, N.Y. 11630)

22-24. An **Equipment Manuals Symp.**, Los Angeles, Calif. (R. Post, Dept. of the Army, Materiel Command, Washington, D.C. 20315)

24-26. **Linguistic Soc. of America**, Columbus, Ohio. (T. A. Sebeck, Patton House, Indiana Univ., Bloomington 47401)

25-1. Institute on **Religion in an Age of Science**, Star Island (Portsmouth), N.H. (Mrs. E. R. Goodenough, 89 Irving St., Cambridge, Mass. 02138)

26-1. **Water Pollution Research**, 5th intern. conf., San Francisco, Calif. (J. Parkhurst, California Host Corp., Room 635, Davis Hall, Univ. of California, Berkeley 94720)

27-31. Instrument Soc. of America, Research Conf. on **Instrumentation Science**, 29th, Geneva, N.Y. (N. E. Huston, Univ. of Wisconsin, Madison 53706)

28-30. Conference on **Nondestructive Evaluation**, Philadelphia, Pa. (J. A. Fellows, American Soc. for Metals, Metals Park, Ohio 44073)

29-31. International Symp. on **Bio-mechanics**, San Diego, Calif. (Y. C. Fung, 5022 Basic Science Bldg., Univ. of California, San Diego 92037)

29-31. **Acoustical Holography**, 3rd intern. symp., Newport Beach, Calif. (H. E. Calkins, Douglas Advanced Research Labs., McDonnell Douglas Corp., Huntington Beach, Calif. 92647)

29-1. **Reticuloendothelial Soc.**, 4th intern., Freiburg, Germany. (K. Flemming, 7799 Heiligenberg, Postfach 3, West Germany)

30-1. **Equine Nutrition**, 2nd symp., Ithaca, N.Y. (H. F. Hintz, Dept. of Large Animal Medicine, Cornell Univ., Ithaca 14850)

August

2-5. American Soc. of **Animal Science**, University Park, Pa. (G. P. Lofgreen, Imperial Valley Field Station, 1004 E. Holton Rd., El Centro, Calif. 92243)

19 JUNE 1970

We decided to eliminate some limitations of Metallurgical Microscopes.

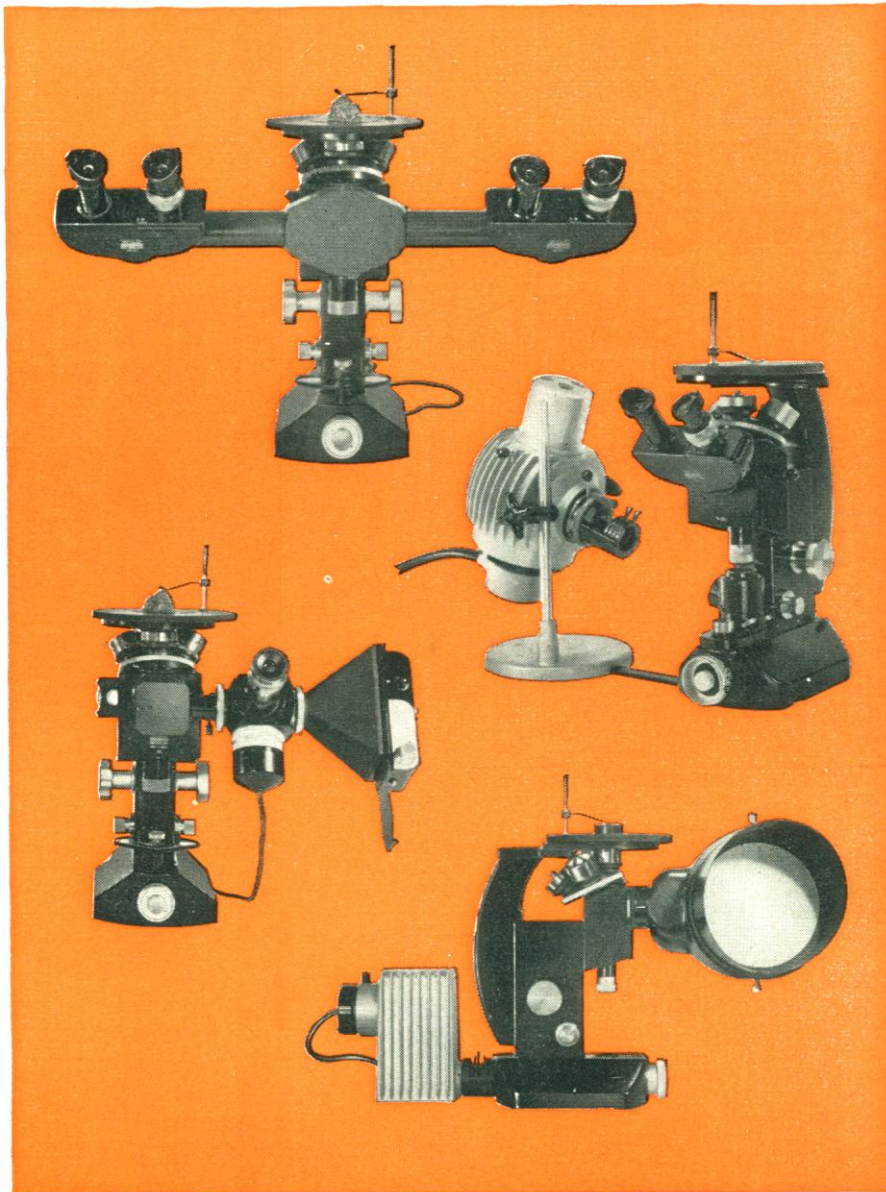

Now there's the Wild M50

Unprecedented versatility for investigating surface structures in incident light.

The stability to assure vibration-free observation even in photomicrography.

Combine these M50 features with 1. The world's finest optics and mechanical precision. 2. A complete range of accessories for photomicrography, projection, and discussion. 3. Fingertip switching from darkfield to brightfield. 4. Polarizing feature. 5. Inverted construction for all size specimens.

You'll conclude that in Metallurgical Microscopes, there's the Wild M50.

Write or call for Booklet M50.

WILD[®]
HEERBRUGG

WILD HEERBRUGG INSTRUMENTS, INC.
FARMINGDALE, NEW YORK 11735

Wild of Canada, Ltd.
881 Lady Ellen Place
Ottawa 3, Ontario

Wild de Mexico, SA
Londres 256
Mexico 6, D. F.

Circle No. 26 on Readers' Service Card

1495

2-5. **Primitology**, 3rd intern. congr. Zurich, Switzerland. (J. Biegert, Anthropological Inst., Univ. of Zurich, CH 8001, Zurich)

2-6. **National Medical Assoc.**, Atlanta, Ga. (E. C. Walden, 4200 Edmonson Ave., Baltimore, Md. 21229)

2-7. **Society for Industrial Microbiology**, Kingston, R.I. (V. S. Kenny, Gagliardi Research Corp., P.O. Box 390, East Greenwich, R.I. 02818)

3-4. **American Soc. of Safety Engineers**, San Diego, Calif. (A. C. Blackman, The Society, 850 Busse Highway, Park Ridge, Ill. 60068)

3-7. **Future Implications of Biomedical Technologies Conf.**, Deerfield, Mass. (C. Williams, National Science Foundation, Washington, D.C.)

3-7. **American College of Chest Physicians**, 11th intern. congr. on Diseases of the Chest, Lausanne, Switzerland. (M. Kornfield, 112 E. Chestnut St., Chicago, Ill. 60611)

5-7. **Engineering in Medicine—Bioceramics Conf.**, Henniker, N.H. (C. W. Hall, Southwest Research Inst., San Antonio, Tex.)

3-7. **Molecular Biology and Pathology**, 3rd conf., Saratoga Springs, N.Y. (K. T. Lee, Dept. of Pathology, Albany Medical College, Albany, N.Y. 12208)

4-6. **Stress Corrosion Cracking Conf.**, Philadelphia, Pa. (J. A. Fellows, American Soc. for Metals, Metals Park, Ohio 44073)

5-7. **Association of American Feed Control Officials**, Louisville, Ky. (B. Poundstone, Kentucky Agricultural Experiment Sta., Univ. of Kentucky, Lexington 40506)

5-7. **Applications of X-Ray Analysis**, 19th conf., Denver, Colo. (J. B. Newkirk, Dept. of Metallurgy, Univ. of Denver, Denver 80210)

5-12. **International Council on Health, Physical Education and Recreation**, Sydney, Australia. (A. Willee, Dept. of Physical Education, Univ. of Melbourne, Melbourne, Australia)

6-15. **Antarctic Geology and Solid Earth Geophysics**, intern. symp., Oslo, Norway. (L. DeGoes, Natl. Acad. of Sciences, 2101 Constitution Ave., NW, Washington, D.C. 20418)

9-12. **Soil Conservation Soc. of America**, Toronto, Ont., Canada. (H. W. Pritchard, 7515 NE Ankeny Rd., Ankeny, Iowa 50021)

9-13. **Biocommunications 70 Conf.**, Houston, Tex. (H. R. Smith, Medical Illustration, Room 414E, Baylor College of Medicine, Houston 77025)

9-14. **Food Science and Technology**, 3rd intern. congr., Washington, D.C. (C. L. Willey, Inst. of Food Technologists, 221 N. LaSalle St., Chicago, Ill. 60601)

9-15. **Microbiology**, 10th intern. congr., Mexico City, Mexico. (L. F. Bojalil, Apartado Postal P.O. Box 60-603, Mexico 18, D.F. Mexico)

10-13. **Society of Automotive Engi-**

neers, Los Angeles, Calif. (W. Marble, 2 Pennsylvania Plaza, New York 10001)

10-14. **Continuing Engineering Education**, Andover, N.H. (W. M. Mueller, Amer. Soc. for Metals, Metals Park, Ohio)

10-14. **Environmental Aspects of Nuclear Power Stations Symp.**, New York, N.Y. (J. H. Kane, Div. for Technical Information, U.S. Atomic Energy Commission, Washington, D.C. 20545)

10-14. **Particulate Matter Systems Conf.**, Deerfield, Mass. (D. W. Fuerstenaun, Univ. of California, Berkeley)

11-13. **Photovoltaic Specialists Conf.**, Seattle, Wash. (J. Loferski, Div. of Engineering, Brown Univ., Providence, R.I.)

16-18. **American Acad. of Physical Medicine and Rehabilitation**, New York, N.Y. (C. C. Herold, 30 N. Michigan Ave., Chicago, Ill. 60602)

16-21. **World Medical Assoc.**, 24th general assembly, Oslo, Norway. (A. E. Romnaldez, 10 Columbus Circle, New York 10019)

16-27. **Wool Research**, 4th intern. conf., Berkeley, Calif. (H. Lundgren, U.S. Dept. of Agriculture, 800 Buchanan St., Albany, Calif. 94710)

17-19. **Alaska Science Conf.**, 21st annual, College. (Hannelore, c/o Dept. of Civil Engineering, Univ. of Alaska, College 99701)

17-19. **American Peptide Symp.**, 2nd, Cleveland, Ohio. (R. R. Smeby, Cleveland Clinic Foundation, 2020 E. 93 St., Cleveland)

Klett Summerson Photoelectric Colorimeter

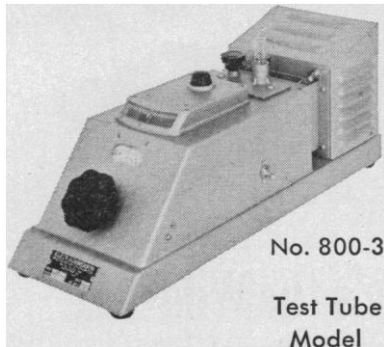

KLETT COLONY MARKER and TALLY

This instrument takes the drudgery and error out of the counting of bacterial colonies.

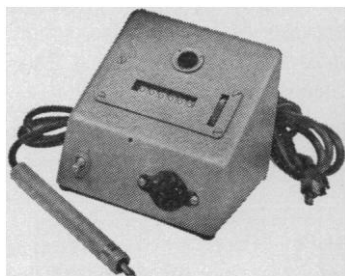

Klett MANUFACTURING CO., INC.,
179 East 87th Street, New York, 28, N.Y.

Circle No. 104 on Readers' Service Card

Labex Giveth, And Labex Takes Away.

There are only two kinds of scientific equipment: the kind you need and the kind you don't.

We are the marketplace, the exchange, the center for both.

Write us or call now for the latest list of what we've got. Or tell us what you'd like us to take away.

Labex. (312) 787-0800

Labex Laboratory Instrument Exchange, Inc.
301 E. Erie Street, Chicago, Illinois 60611

Circle No. 103 on Readers' Service Card

WORKHORSE!

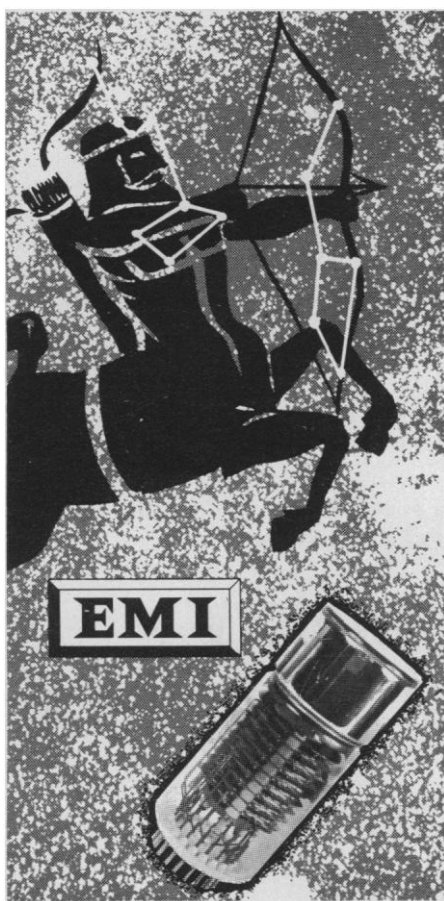

TYPE 9750

Nothing fancy, and not expensive. Just a good old 10 stage photo-multiplier but: It has a superb bialkali cathode with excellent collection efficiency (which is fundamental for good S/N ratio), highly stable CsSb dynodes which provide a gain of 10^6 at just over 1,000 volts, and a dark current of 10^{-10} A. at that voltage (50 A/L).

As usual EMI has provided a number of variations: 9750QB with a spectroil window for UV and low level counting applications, (liquid scintillation) 9750B with Pyrex window for visible applications, and finally 9750KB for those who prefer the B-14A overcapped base. In the "K" configuration, it is directly interchangeable with our 9656KB or a number of competitive types.

The 9750 with its high quantum efficiency and low dark current gives excellent resolution for low energy gamma rays. When used with a thin two inch sodium iodide crystal with a beryllium window, the resolution for Fe^{55} is of the order of 40%.

Flying spot scanners, photometers, thermoluminescent dosimeters, low level scintillation counting are all applications for which the 9750 is highly suitable. Detailed specifications on request from:

GENCOM DIVISION varian/EMI

80 EXPRESS STREET, PLAINVIEW, N. Y. 11803
TELEPHONE: (516) 433-5900

Circle No. 76 on Readers' Service Card
1498

17-19. Trace Analysis with an Emphasis on Pollution and Environment Factors, Edmonton, Alta., Canada. (J. A. Plamdeck, Dept. of Chemistry, Univ. of Alberta, Edmonton)

17-20. International Conf. on Ephemeroptera, Tallahassee, Fla. (W. L. Peters, P.O. Box 111, Florida A & M Univ., Tallahassee 32307)

17-21. New England Assoc. of Chemistry Teachers, 32nd summer conf., Manchester, N.H. (H. B. Bjornson, 95 Falls Ave., Medford, Mass. 02155)

17-21. Computers in Undergraduate Science Education, Chicago, Ill. (R. Blum, Dept. of Physics and Astronomy, Univ. of Maryland, College Park 20742)

17-21. National Metric Study Conf., Deerfield, Mass. (R. P. Trowbridge, c/o Engineering Foundation, 345 E. 47 St., New York 10017)

17-21. International Assoc. of Milk, Food and Environmental Sanitarians, Cedar Rapids, Iowa. (H. L. Thomasson, P.O. Box 437, Shelbyville, Ind. 46178)

17-21. Symposium on Recovery of Uranium from the Ores and Other Sources, Rio de Janeiro, Brazil. (J. H. Kane, Div. of Technical Information, U.S. Atomic Energy Commission, Washington, D.C. 20545)

17-22. Anatomical Congr., 9th intern., Leningrad, U.S.S.R. (W. Bargmann, Dept. of Anatomy, Univ. of Kiel, Kiel, Germany)

17-22. Carbohydrate Chemistry, 5th intern. symp., Paris, France. (F. Percheron, 4, Ave. de l'Observatoire, 75, Paris 6^e)

18-21. Chemical Engineering Conf., Melbourne, Australia. (P. D. O'Connor, Australian Acad. of Science, Gordon St., Canberra City, A.C.T., 2601)

18-21. Detonation, 5th intern. symp., Pasadena, Calif. (S. J. Jacobs, U.S. Naval Ordnance Lab., Silver Spring, Md. 20910)

18-27. International Astronomical Union, 14th general assembly, Brighton, England. (L. Perak, General Secretary, Astronomical Inst., Czechoslovak Acad. of Science, Prague 2)

19-20. Water Quality, 5th annual intern. symp., Washington, D.C. (David X. Manners Co., 237 East Rocks Rd., Norwalk, Conn. 06851)

19-26. Institute of Mathematical Statistics, Hanover, West Germany. (L. Katz, Statistical Lab., Michigan State Univ., East Lansing 48823)

20-21. American Astronautical Soc., Santa Barbara, Calif. (T. Mitchell, Univ. of California, Santa Barbara)

20-22. Therapy of Advanced Cancer, 9th natl. conf., Madison, Wis. (R. J. Samp, University Hospitals, 1300 University Ave., Madison 53706)

21-23. Soil Geomorphology Field Conf., Tucson, Ariz. (J. W. Hawley, Soil Science Soc. of America, P.O. Box 3129, University Park, N.M. 88001)

23. Botanical Soc. of America, Bloomington, Ind. (B. F. Palser, Dept. of Botany, Rutgers Univ., New Brunswick, N.J. 08903)

23-26. Association of American Geographers, San Francisco, Calif. (J. W. Nystrom, 1146 16th St., Washington, D.C. 20036)

23-27. Phycological Soc. of America,

BEL-ART

POLYETHYLENE RACKS for all purposes

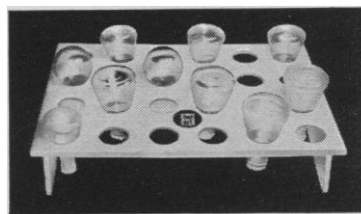

FLASK RACK

Store - Drain - Carry

Holds erlenmeyer flasks in inverted position for draining and safe storage. Also useful for draining round bottom flasks, bottles and similar glassware or storing funnels or separatory funnels.

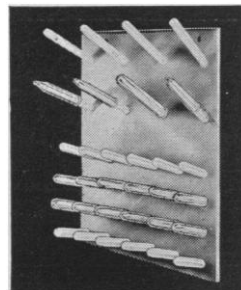

TEST TUBE DRAINING RACK

Impervious to spilled acids. Will accommodate 32 test tubes. 24 pins $3\frac{1}{2}$ " long and 8 pins 5" long. $15\frac{1}{4}$ " x 11". Has holes for hanging.

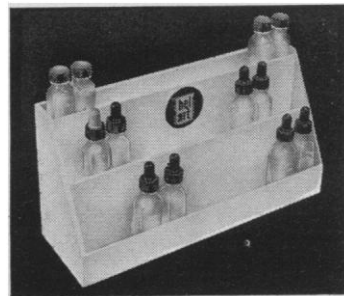

BOTTLE RACK

For semi-micro reagent bottles. Bottom tier holds 10 bottles $1\frac{1}{8}$ " square (1 oz.) Second and top tiers hold 13 bottles $1\frac{1}{8}$ " square ($\frac{1}{2}$ oz.). Tier arrangement provides easy visibility of bottle title and contents.

+++++

Is there a rack you need? Tell us about it. We'll be happy to make any rack to your order.

At your nearest laboratory supply house.

Our NEW supplement is now available. For your FREE copy write Dept. E-6.

BEL-ART PRODUCTS
PEQUANNOCK, N. J. 07440

Circle No. 83 on Readers' Service Card

Bloomington, Ind. (P. L. Walne, Dept. of Botany, Univ. of Tennessee, Knoxville 37916)

23-28. American Soc. of **Agronomy**, Tucson, Ariz. (M. Stelly, 677 S. Segoe Rd., Madison, Wis. 53711)

23-28. International **Diabetes** Federation Symp. and Conf., 7th, Buenos Aires, Argentina. (V. G. Foglia, Paraguay 2155, 7° piso, Buenos Aires)

23-28. International **Law** Assoc. Conf., 54th, The Hague, Netherlands. (A. Cronheim, Holland Organizing Centre, 16, Lange Voorhout, The Hague)

23-28. **Liquid Crystal**, 3rd intern. conf., Berlin, Germany. (R. Hosemann, Fritz-Haber Institut der Max-Planck-Gesellschaft, Faradayweg 46.1, Berlin 33)

23-29. **Crop and Soil Science** Meetings, Tucson, Ariz. (M. Stelly, 677 S. Segoe Rd., Madison, Wis. 53711)

23-29. American **Fern** Soc., Bloomington, Ind. (A. M. Evans, Dept. of Botany, Univ. of Tennessee, Knoxville 37916)

23-29. American Soc. of **Plant Physiologists**, Bloomington, Ind. (W. H. Klein, Radiation Lab., Smithsonian Institution, Washington, D.C. 20560)

23-29. American Soc. of **Plant Taxonomists**, Bloomington, Ind. (L. I. Neveling, Jr., Arnold Arboretum and Gray Herbarium, 22 Divinity Ave., Cambridge, Mass. 02138)

23-29. American Soc. of **Zoologists**, Bloomington, Ind. (G. Sprugel, Jr., Illinois Natural History Survey, 179 Natural Resources Bldg., Urbana 61801)

24-26. **Chemical Engineering** Conf., Sydney, Australia. (P. D. O'Connor, Secy., Australian Acad. of Science, Gordon St., Canberra City, A.C.T., 2601)

24-26. **Energy and the Environment**, 24th annual conf., Oak Ridge, Tenn. (W. W. Grigorieff, Special Projects Office, Oak Ridge Associated Universities, P.O. Box 117, Oak Ridge 37830)

24-26. **Genetics** Soc. of America, Seattle, Wash. (B. Wallace, Dept. of Genetics, Cornell Univ., Ithaca, N.Y. 14850)

24-26. **Mathematical** Assoc. of America, Laramie, Wyo. (A. B. Willcox, The Association, 1225 Connecticut Ave., NW, Washington, D.C. 20036)

24-26. International Conf. on **Psychosurgery**, Copenhagen, Denmark. (E. R. Hitchcock, Dept. of Surgical Neurology, Royal Infirmary, Edinburgh, Scotland)

24-26. International Conf. on **Radiation Effects in Semiconductors**, Albany, N.Y. (J. W. Corbett, Dept. of Physics, State Univ. of New York at Albany, Albany 12203)

24-27. **Soil Science** Soc. of America, Tucson, Ariz. (J. W. Hawley, The Society, P.O. Box 3129, University Park, N.M.)

24-28. Application of **Environmental R & D to Landfill Disposal for Solid Wastes**, Deerfield, Mass. (E. A. Glysson, Univ. of Michigan, Ann Arbor)

24-28. Quantitative Decision Making for Delivery of **Health Care**, Andover, N.H. (A. Jacobs, Univ. of Rochester, Rochester, N.Y.)

24-29. Congress of Intern. Soc. of **Haematology**, Munich, Germany. (J. L. Tullis, 110 Francis St., Boston, Mass. 02215)

25-28. Symposium on the **Chromosphere-Corona Transition Region**, Boulder,

19 JUNE 1970

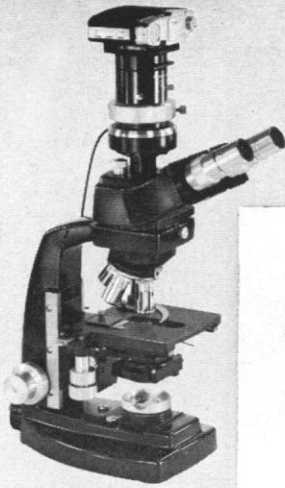

BAUSCH & LOMB 
SCIENTIFIC INSTRUMENT DIVISION

Anatomy of flat fields

Here's an "x-ray" of a sensational optical breakthrough that makes Bausch & Lomb first with truly flat fields, priced competitively with conventional, achromatic systems. Now you can afford flat, edge-to-edge images by specifying DynaZoom® or Dynoptic® Flat Field microscopes. Such performance cannot be matched for anywhere near the Bausch & Lomb price. But—let your own eyes decide. We can arrange for you to try a DynaZoom in your own laboratory.

Meanwhile, we will send you the deluxe Laboratory Microscope brochure, 31-185. Just write Bausch & Lomb, 85630 Bausch Street, Rochester, New York 14602.

Circle No. 28 on Readers' Service Card

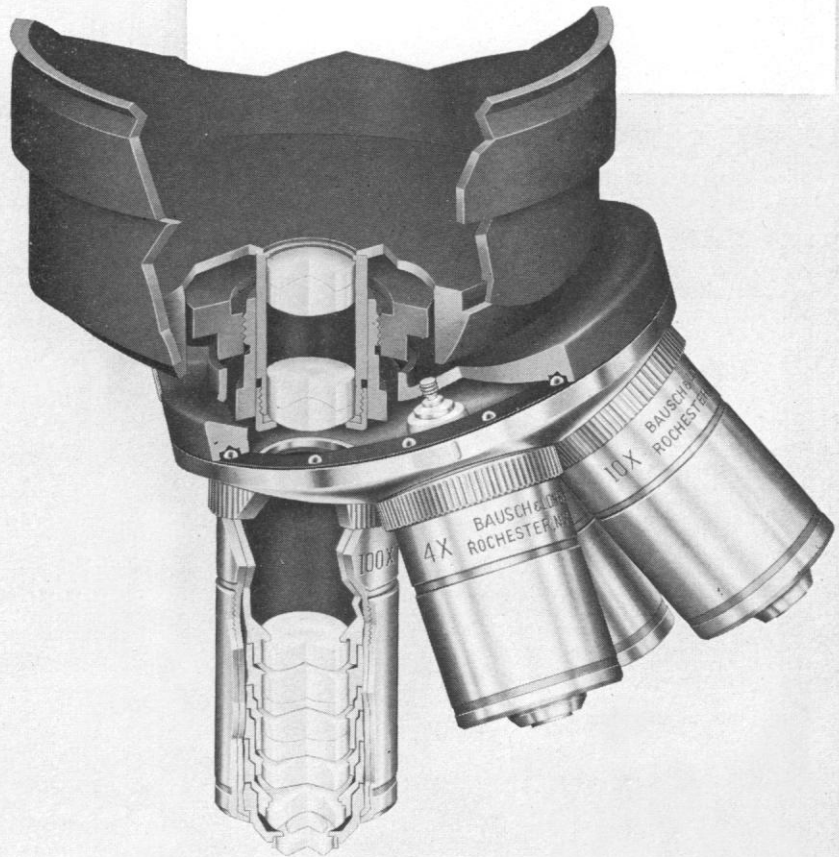

See inimitable quality in microvision . . .
See a demonstration of DynaZoom/Flat Field

Colo. (J. W. Evans, Director, Sacramento Park Observatory, Sunspot, N.M. 88349)

25-28. Western **Electronic Show and Convention**, Los Angeles, Calif. (R. Howard, WESCON, 3600 Wilshire Blvd., Los Angeles 90005)

25-28. Institute of **Mathematical Statistics**, Laramie, Wyo. (L. Katz, Statistical Lab., Michigan State Univ., East Lansing 48823)

26-29. **Small-Angle X-Ray Scattering**, 2nd intern. conf., Graz, Austria. (O. Kratky, Inst. for Physical Chemistry, Univ. of Graz, Heinrichstrasse 28, A-8010 Graz)

27-30. Society for the Study of **Amphibians and Reptiles**, 13th annual, Kansas City, Mo. (J. L. Vial, Dept. of Biology, Univ. of Missouri, Kansas City 64110)

28-30. International **Mathematical Union**, 6th general, Menton, France. (C. B. Morrey, Jr., Dept. of Mathematics, Univ. of California, Berkeley)

28-30. **Soil Geomorphology Field Conf.**, Tucson, Ariz. (J. W. Hawley, Soil Science Soc. of America, P.O. Box 3129, University Park, N.M. 88001)

28-1. American **Quaternary Assoc.**, Yellowstone Natl. Park and Bozeman, Mont. (M. Davis, Great Lakes Research Div., Univ. of Michigan, Ann Arbor 48104)

28-2. International **Mineralogical Assoc.**, 7th congr., Tokyo, Japan. (C. E. Tilley, Dept. of Mineralogy and Petrology, Univ. of Cambridge, Cambridge, England)

29-3. American **Physiological Soc.**, Bloomington, Ind. (H. Hazelrigg, News Bureau, Indiana Univ., 306 N. Union St., Bloomington 47401)

30-2. American Inst. of **Chemical Engineering**, Denver, Colo. (J. Henry, 345 E. 47 St., New York 10017)

30-2. **Electronic Materials** Technical Conf., New York, N.Y. (A. Reisman, I.B.M., P.O. Box 218, Yorktown Heights, N.Y. 10598)

30-2. **Geological Assoc. of Canada and Mineralogical Assoc. of Canada**, Winnipeg, Man. (R. F. J. Scoates, Manitoba Mines Branch, 900 Norguay Bldg., Winnipeg)

30-4. **Laurentian Hormone Cont.**, Quebec, Canada. (J. Sanford, Laurentian Conf. Office, 222 Maple Ave., Shrewsbury, Mass. 01545)

30-4. **Strength of Metals and Alloys**, 2nd intern. conf., Asilomar, Calif. (J. A. Fellows, American Soc. for Metals, Metals Park, Ohio 44073)

30-5. **History of Medicine**, 22nd intern. congr., Bucharest, Rumania. (B. Dutescu, Strada Rozelar 13, Bucharest)

30-5. **Ornithological Congr.**, 15th intern., The Hague, Netherlands. (N. Tinbergen, Dept. of Zoology, Parks Rd., Oxford, England)

31-2. Symposium on **Heteroatom Chemistry**, London, Ont., Canada. (D. H. Hunter, Dept of Chemistry, Univ. of Western Ontario, London)

31-3. American **Sociological Assoc.**, Washington, D.C. (E. H. Volkart, 1001 Connecticut Ave., NW, Washington, D.C. 20036)

31-4. **Modern Concepts in Corrosion Engineering**, Andover, N.H. (W. H. Boyd, Battelle Memorial Inst., Columbus, Ohio)

31-4. American Soc. of **Limnology and Oceanography**, Kingston, R.I. (G. H. Lauff, W. W. Kellogg Biological Sta., Michigan State Univ., Hickory Corners 49060)

31-4. **Neuropathology**, 7th intern. congr., Paris, France. (J. Lapresle, Hôpital de la Salpêtrière, 47 Bld. de l'Hôpital, 75 Paris 13^e)

31-4. Symposium on **Polarisation Phenomena in Nuclear Reactions**, Madison, Wis. (J. Teillard, Laboratoire Joliot-Curie, Faculté des Sciences d'Orsay, Orsay 91, France)

31-4. **Poultry Science Assoc.**, Knoxville, Tenn. (C. B. Ryan, Texas A & M Univ., College Station 77843)

September

1-3. Association for **Computing Machinery**, 25th natl. conf., New York, N.Y. (S. Matsa, IBM Corp., 410 E. 62 St., New York 10021)

1-3. **Nuclear Power in 1970**, Williamsburg, Va. (W. Thomas, American Nuclear Soc., Virginia Electric & Power, 7th and Franklin, Richmond, Va. 23219)

1-10. International **Mathematical Union**, 6th general assembly and intern. congr. of mathematicians, Nice, France. (J. Dieudonne, c/o Faculty of Science, Univ. of Nice, Nice)

2-9. British Assoc. for the **Advancement of Science**, Durham, England. (J. M. Robertson, 3 Sanctuary Bldgs., 20 Great Smith St., London S.W.1, England)

3-5. **Mineralogical Assoc. of Canada and Geological Assoc. of Canada**, joint annual mtg., Winnipeg, Man. (D. T. Anderson, Dept. of Geology, Univ. of Manitoba, Winnipeg)

3-9. International Union of **Biochemistry**, 8th intern. congr., Rome, Italy. (P. Desnuelle, Inst. de Chimie Biologique, Faculté des Sciences, Place Victor-Hugo 13, Marseille, France)

4-8. Society of General **Physiologists**, Woods Hole, Mass. (M. Lieberman, Dept. of Physiology, Duke Univ., Durham, N.C.)

4-8. American **Psychological Assoc.**, Miami Beach, Fla. (K. B. Little, APA, 1200 17th St., NW, Washington, D.C. 20036)

6-12. **World's Poultry Science Assoc.**, 14th world congr., Madrid, Spain. (R. Cole, Agriculture House, Knightsbridge, London, S.W.1, England)

6-12. Society of **Protozoologists**, Washington, D.C. (D. M. Hammond, Dept. of Zoology, Utah State Univ., Logan 84321)

7-11. **Behavioral Temperature Regulation**, Lyon, France. (J. D. Hardy, John B. Pierce Foundation Lab., 290 Congress Ave., New Haven, Conn. 06519)

7-11. International Congr. on **Cybernetics**, 6th, Namur, Belgium. (G. R. Boulanger, Palais des Expositions, Place Andre Rijckmans, Namur)

7-11. Symposium on **Developments in the Management of Low and Intermediate Level Radioactive Wastes**, Aix-en-Provence, France. (J. H. Kane, Div. of Technical Information, U.S. Atomic Energy Commission, Washington, D.C. 20545)

7-11. International Congr. of the **Transplantation Soc.**, 3rd, The Hague, Netherlands. (A. Cronheim, Holland Organizing Centre, 16, Lange Voorhout, The Hague)

7-12. **Cardiology**, 6th world congr. London, England. (J. Shillingford, British Cardiac Soc., Postgraduate Medical School, Ducane Rd., London W.12)

7-12. International Assoc. of **Geochem-**

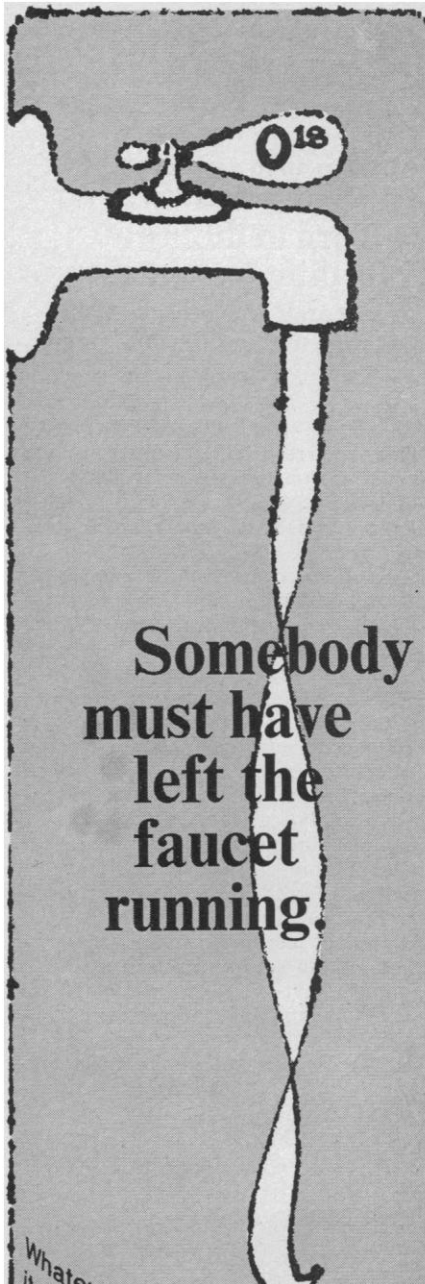

Somebody must have left the faucet running.

Whatever the cause, Bio-Rad finds itself with a huge supply of low-deuterium O¹⁸ water on hand. So we've priced it 10% lower than you can buy it elsewhere.

If you have a sensitive instrument, our low enriched O¹⁸ will prove to be a satisfactory replacement for "normalized" water for many applications involving isotope effects. And it will save you an additional 25%.

Bio-Rad also has D₂O in abundance, including 100% D₂O (new with us).

For prices and full details on heavy water and stable isotopes, please contact

BIO-RAD Laboratories

32nd & Griffin Avenue, Richmond, Calif. 94804 • Phone (415) 234-4130



**Step up to new levels
of enzyme purity . . .
Turn to the new
Worthington catalog
for research enzymes, enzyme
reagents, nucleotides and new
analytical services**

Our new catalog contains what you would expect—hundreds of high-purity enzymes for research, and our complete group of enzyme reagents for the clinical laboratory.

And it contains a lot more that is completely new:

- **Nucleotides**, comprised of a group of 73 basic compounds frequently required in biochemical and clinical laboratories.
- **Premium enzymes**, consisting of 18 fully-characterized enzyme products of outstanding purity and activity.
- **Radioactive enzymes**, including seven hydrolytic enzymes and four tritiated substrates, which make highly sensitive analytical tools.
- **Enzymes in quantity**, comparable to Worthington research enzymes in quality, offered for use in other products or processes.
- **Analytical services**, including complete amino acid and ultracentrifugal analysis, available to individual researchers and institutions on a contract basis.

All told, our catalog offers the most complete range of products and services related to the multiple aspects of enzymology. Use the attached coupon to request your personal copy and another one for an associate.

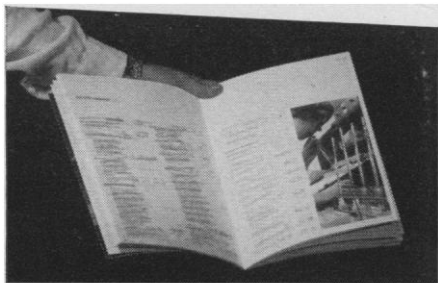

Worthington Biochemical Corporation

Freehold, New Jersey 07728

Please send the following:

- copies of catalog, Products and Services of Worthington Biochemical Corporation
- Product literature on Worthington enzyme reagents for the clinical laboratory

Name _____

Title _____

Organization _____

Address _____

City _____

State _____ Zip _____

Circle No. 85 on Readers' Service Card

istry and Cosmochemistry, Oslo, Norway. (E. Andersen, Reactor School, Inst. for Atomenergi, 2007 Kjeller, Norway)

7-12. Pharmaceutical Sciences, 31st annual intern. congr., Washington, D.C. (G. B. Griffenhagen, American Pharmaceutical Assoc., 2215 Constitution Ave., NW, Washington, D.C.)

7-12. Magnetism, intern. conf., International Union of Pure and Applied Physics, Grenoble, France. (W. C. Marshall, Atomic Energy Research Establishment, Harwell, England)

8-11. American Chemical Soc., Molecular Sieve Zeolites, 2nd intern. congr., Worcester, Mass. (L. B. Sand, Dept. of Chemical Engineering, Worcester Polytechnical Inst., Worcester 01609)

8-12. Symposium on Molecular Structure and Spectroscopy, Columbus, Ohio. (K. N. Rao, Dept. of Physics, Ohio State Univ., Columbus 43210)

9-11. Canadian Medical and Biological Engineering Conf., 3rd, Halifax, Nova Scotia, Canada. (D. Mutch, Nova Scotia Technical College, P.O. Box 1000, Halifax)

9-13. American Electroencephalographic Soc., Washington, D.C. (P. T. White, 8700 W. Wisconsin, Milwaukee, Wis. 53226)

10-12. Electrical Double Layer and Its Influence on Electrode Processes Conf., Lexington, Ky. (G. D. Christian, Dept. of Chemistry, Univ. of Kentucky, Lexington 40506)

10-12. Parapsychological Assoc., 13th annual intern. conv., New York, N.Y. (J. G. Pratt, Box 152, Univ. of Virginia School of Medicine, Charlottesville 22901)

11-12. Utah Acad. of Sciences, Arts and Letters. (K. T. Slack, University of Utah, Salt Lake City 84112)

11-19. American Soc. of Clinical Pathologists, Atlanta, Ga. (M. Damron, 445 N. Lake Shore Dr., Chicago, Ill. 60611)

13-16. American Fisheries Soc. centennial celebration mtg., New York, N.Y. (R. F. Hutton, AFS, 15th and New York Ave., NW, Washington, D.C. 20005)

13-17. American Soc. of Mechanical Engineers, petroleum mechanical engineering conf., Denver, Colo. (A. B. Conlin, 345 E. 47 St., New York 10017)

13-17. Raman Spectroscopy, 2nd intern. conf., Oxford, England. (D. A. Long, Dept. of Structural Chemistry, Univ. of Bradford, Bradford 7, Yorkshire, England)

13-18. American Chemical Soc., Chicago, Ill. (F. T. Wall, Executive Director, ACS, 1155 16th St., NW, Washington, D.C. 20036)

13-18. Illuminating Engineering Soc., natl. technical conf., Vancouver, B.C., Canada. (R. C. Ringold, 345 E. 47 St., New York 10017)

14-17. American Hospital Assoc., 72nd annual, Houston, Tex. (E. L. Crosby, The Association, 840 Lake Shore Dr., Chicago, Ill. 60611)

14-17. Society of Photo-Optical Instrumentation Engineers, technical symp., Anaheim, Calif. (H. F. Sander, 216 Avenida Del Norte, Redondo Beach, Calif. 90277)

14-18. International Council of the Aeronautical Sciences Congr., Rome, Italy. (R. R. Dexter, c/o American Inst. of Aeronautics and Astronautics, 1290 Sixth Ave., New York 10009)



**NOW IN
AMERICA**

through the Sobotka
Organization

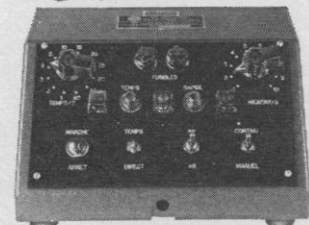
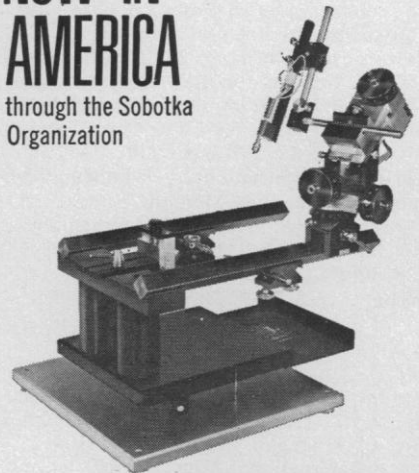

**AN
INCOMPARABLY
SUPERIOR
MICROMANIPULATOR**

One of a complete selection of fine stereotaxic instruments and micromanipulators from La Precision Cinematographique (France).

Forget that name, because the whole world knows this instrument as LPC Electronic Micromanipulator "Kel". It's a classic in engineering, versatility, and quality... throughout.

"Kel" offers great freedom in manipulation. Micrometer movements may be programmed electronically to permit observation without an oscilloscope. The cell may be observed constantly; penetration made at will. Repeat penetration is possible at the precise point. "Kel" can be used on nearly all stereotaxic instruments. Unique electrode control eliminates all vibrations caused by touching the instrument.

Write or Call for Literature

**eric sobotka
company, inc.**

Importers and Distributors of
Microscopes and Scientific Instruments

Finn Court, Farmingdale, N.Y. 11735 • 516-293-9272

Circle No. 77 on Readers' Service Card