

EIGHT DARLINGTON ARRAYS

- EIGHT DARLINGTONS PER PACKAGE
- **EXTENDED TEMPERATURE RANGE**
 (- 40 to 105°C)
- OUTPUT CURRENT TO 500mA
- OUTPUT VOLTAGE TO 50V
- INTEGRAL SUPPRESSION DIODES
- VERSIONS FOR ALL POPULAR LOGIC FAMILIES
- OUTPUT CAN BE PARALLELED
- INPUTS PINNED OPPOSITE OUTPUTS TO SIMPLIFY BOARD LAYOUT

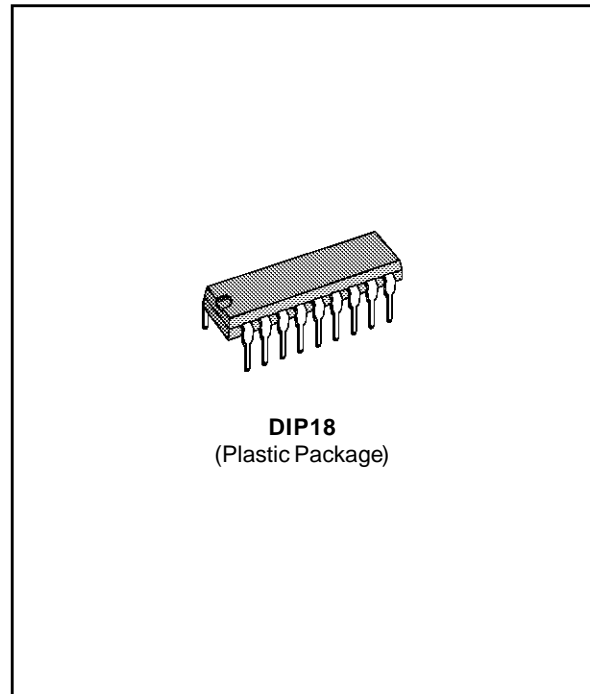

DESCRIPTION

The ULQ2801A-ULQ2805A each contain eight darlington transistors with common emitters and integral suppression diodes for inductive loads. Each darlington features a peak load current rating of 600mA (500mA continuous) and can withstand at least 50V in the off state. Outputs may be paralleled for higher current capability.

Five versions are available to simplify interfacing to standard logic families : the ULQ2801A is designed for general purpose applications with a current limit resistor ; the ULQ2802A has a 10.5kΩ input resistor and zener for 14-25V PMOS ; the ULQ2803A has a 2.7kΩ input resistor for 5V TTL and CMOS ; the ULQ2804A has a 10.5kΩ input resistor for 6-15V CMOS and the ULQ2805A is designed to sink a minimum of 350mA for standard and Schottky TTL where higher output current is required.

All types are supplied in a 18-lead plastic DIP with a copper lead frame and feature the convenient input-opposite-output pinout to simplify board layout.

PIN CONNECTION (top view)

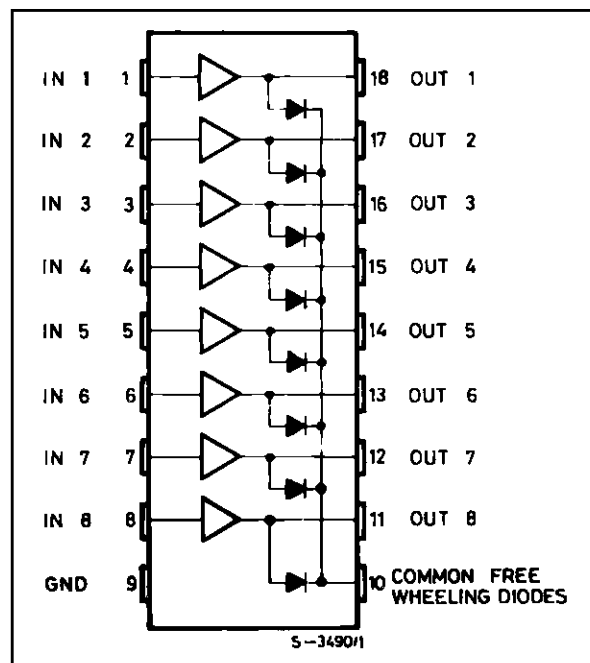

ULQ2801A - ULQ2802A - ULQ2803A - ULQ2804A - ULQ2805A

SCHEMATIC DIAGRAM AND ORDER CODES

For ULQ2801A (each driver for PMOS-CMOS) For ULQ2802A (each driver for 14-15 V PMOS)

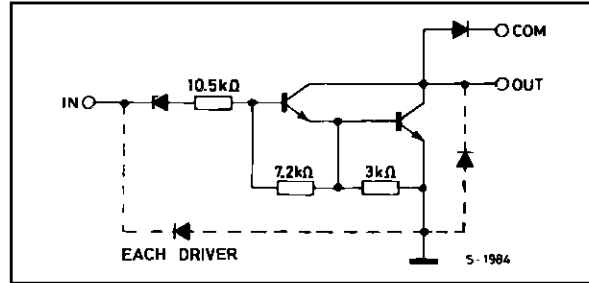
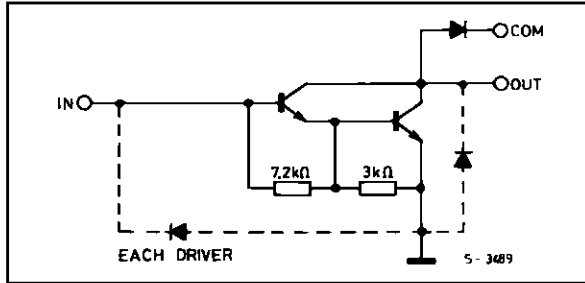

For ULQ2803A (each driver for 5 V, TTL/CMOS)

For ULQ2804A (each driver for 6-15 V CMOS/PMOS)

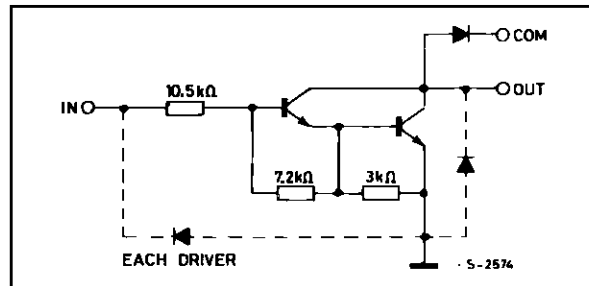
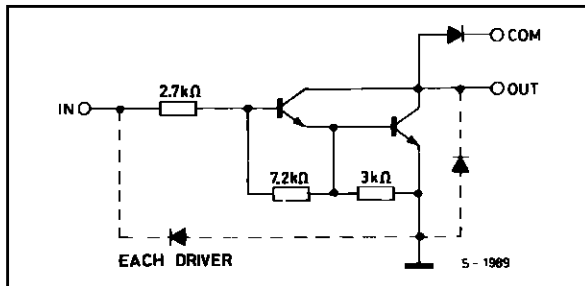

For ULQ2805A (each driver for high out TTL)

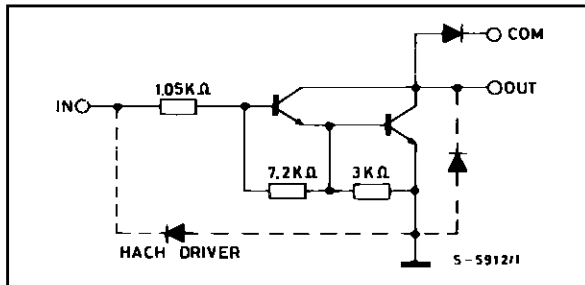

ABSOLUTE MAXIMUM RATINGS

Symbol	Parameter	Value	Unit
V_o	Output Voltage	50	V
V_i	Input Voltage for ULQ2802A, 2803A, 2804A for ULQ2805A	30 15	V V
I_C	Continuous Collector Current	500	mA
I_B	Continuous Base Current	25	mA
P_{tot}	Power Dissipation (one Darlington pair) (total package)	1.0 2.25	W W
T_{amb}	Operating Ambient Temperature Range	- 40 to 105	°C
T_{stg}	Storage Temperature Range	- 55 to 150	°C

THERMAL DATA

Symbol	Parameter	Value	Unit
$R_{th\ j-amb}$	Thermal Resistance Junction-ambient	Max. 55	°C/W

ULQ2801A - ULQ2802A - ULQ2803A - ULQ2804A - ULQ2805A

ELECTRICAL CHARACTERISTICS ($T_j = -40$ to 105°C , unless otherwise specified)

Symbol	Parameter	Test Conditions	Min.	Typ.	Max.	Unit	Fig.
I_{CEX}	Output Leakage Current	$V_{CE} = 50\text{V}$ $T_J = 105^\circ\text{C}$, $V_{CE} = 50\text{V}$			50	μA	1a
		$T_J = 105^\circ\text{C}$ for ULQ2802A $V_{CE} = 50\text{V}$, $V_i = 6\text{V}$ for ULQ2804A $V_{CE} = 50\text{V}$, $V_i = 1\text{V}$			500	μA	1b
$V_{CE(sat)}$	Collector-emitter Saturation Voltage	$I_C = 100\text{mA}$, $I_B = 250\mu\text{A}$		0.9	1.1	V	2
		$I_C = 200\text{mA}$, $I_B = 350\mu\text{A}$		1.1	1.3	V	
		$I_C = 350\text{mA}$, $I_B = 500\mu\text{A}$		1.3	1.6	V	
$I_{i(on)}$	Input Current	for ULQ2802A $V_i = 17\text{V}$		0.82	1.25	mA	3
		for ULQ2803A $V_i = 3.85\text{V}$		0.93	1.35	mA	
		for ULQ2804A $V_i = 5\text{V}$		0.35	0.5	mA	
		for ULQ2805A $V_i = 12\text{V}$		1	1.45	mA	
$I_{i(off)}$	Input Current	$T_J = 105^\circ\text{C}$, $I_C = 500\mu\text{A}$	50	65		μA	4
$V_{i(on)}$	Input Voltage	for ULQ2802A $V_{CE} = 2\text{V}$, $I_C = 300\text{mA}$			13	V	5
		for ULQ2803A $V_{CE} = 2\text{V}$, $I_C = 200\text{mA}$			2.4	V	
		$V_{CE} = 2\text{V}$, $I_C = 250\text{mA}$			2.7	V	
		for ULQ2804A $V_{CE} = 2\text{V}$, $I_C = 300\text{mA}$			3	V	
		$V_{CE} = 2\text{V}$, $I_C = 125\text{mA}$			5	V	
		$V_{CE} = 2\text{V}$, $I_C = 200\text{mA}$			6	V	
		$V_{CE} = 2\text{V}$, $I_C = 275\text{mA}$			7	V	
		for ULQ2805A $V_{CE} = 2\text{V}$, $I_C = 350\text{mA}$			8	V	
h_{FE}	DC Forward Current Gain	for ULQ2802A $V_{CE} = 2\text{V}$, $I_C = 350\text{mA}$	1000			–	2
C_i	Input Capacitance			15	25 (*)	pF	–
t_{PLH}	Turn-on Delay Time	$0.5 V_i$ to $0.5 V_o$		0.25	1 (*)	μs	–
t_{PHL}	Turn-off Delay Time	$0.5 V_i$ to $0.5 V_o$		0.25	1 (*)	μs	–
I_R	Clamp Diode Leakage Current	$V_R = 50\text{V}$ $T_J = 105^\circ\text{C}$, $V_R = 50\text{V}$			50	μA	6
					100	μA	
V_F	Clamp Diode Forward Voltage	$I_F = 350\text{mA}$		1.7	2	V	7

(*) Guaranteed by design

TEST CIRCUITS

Figure 1a.

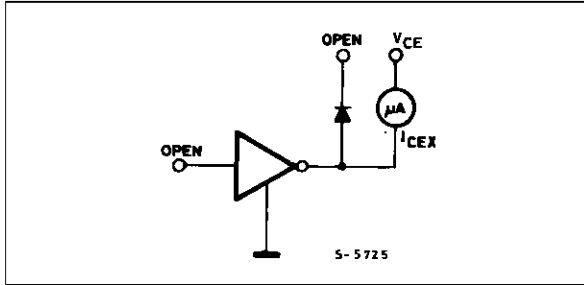

Figure 1b.

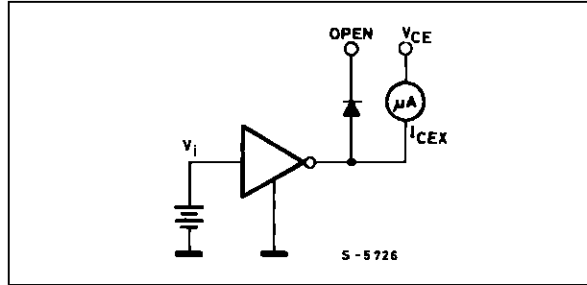

Figure 2.

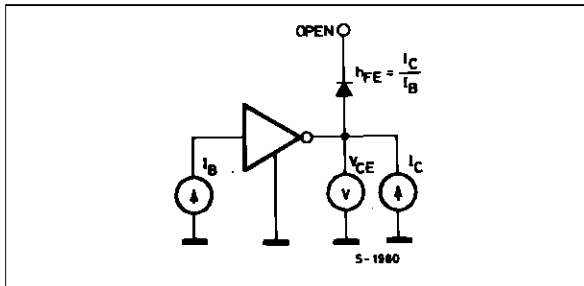

Figure 3.

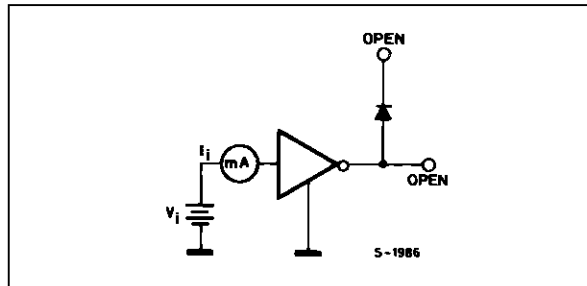

Figure 4.

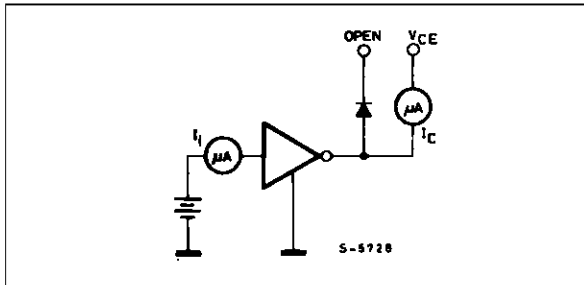

Figure 5.

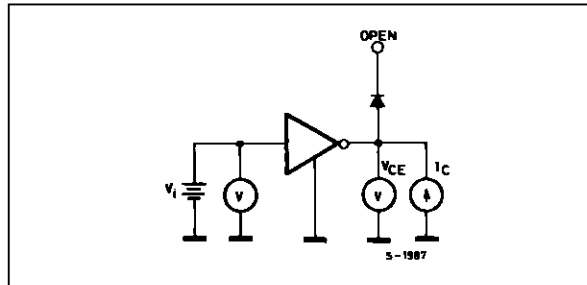

Figure 6.

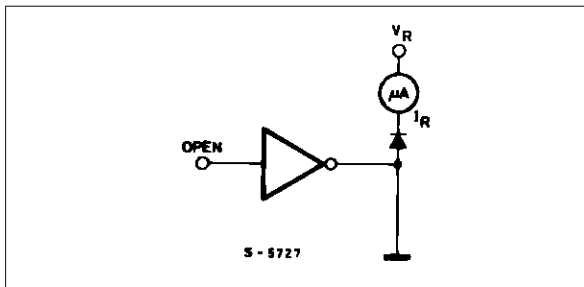

Figure 7.

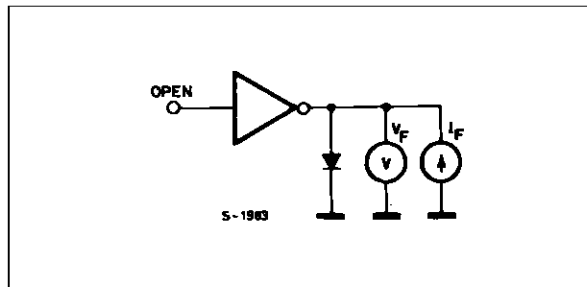

Figure 8 : Collector Current as a Function of Saturation Voltage.

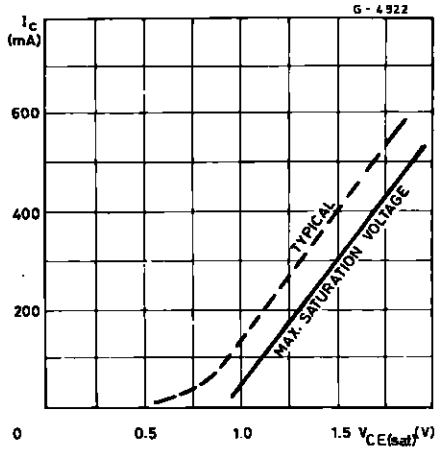

Figure 9 : Collector Current as a Function of Input Current.

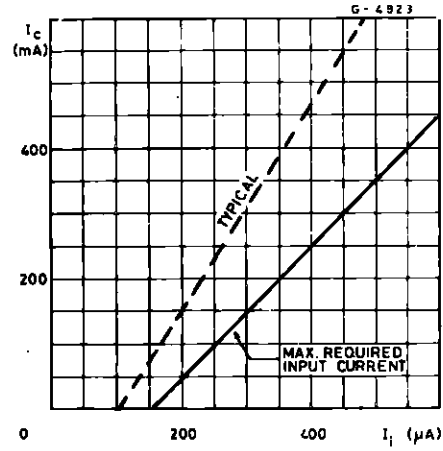

Figure 10 : Allowable Average Power Dissipation as a Function of Ambient Temperature.

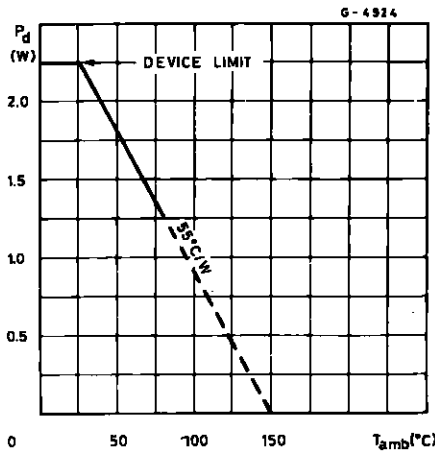

Figure 11 : Peak Collector Current as a Function of Duty Cycle.

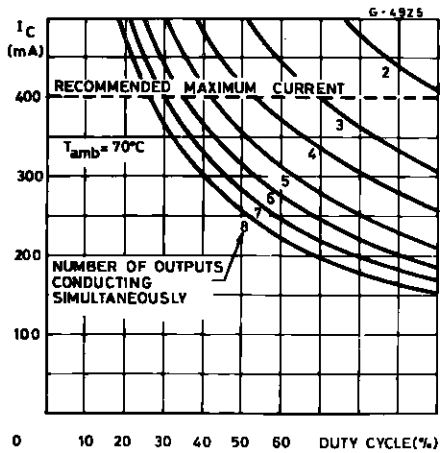

Figure 12 : Peak Collector Current as a Function of Duty.

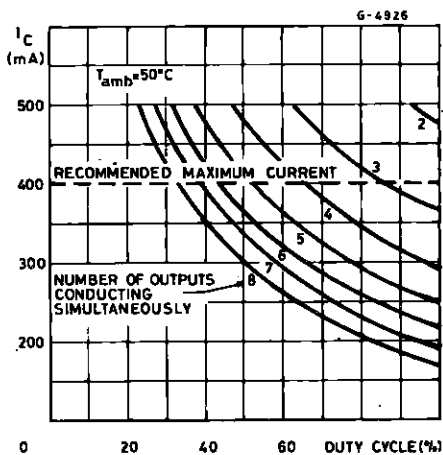

Figure 13 : Input Current as a Function of Input Voltage (for ULQ2802A).

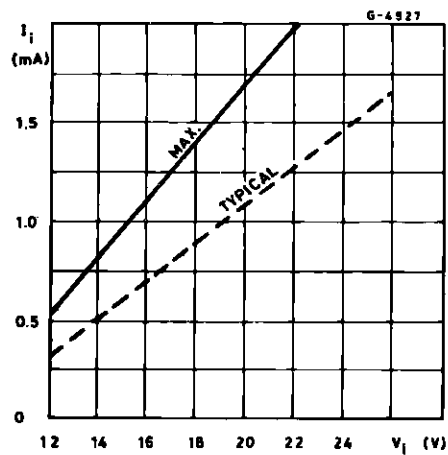

Figure 14 : Input Current as a Function of Input Voltage (for ULQ2804A)

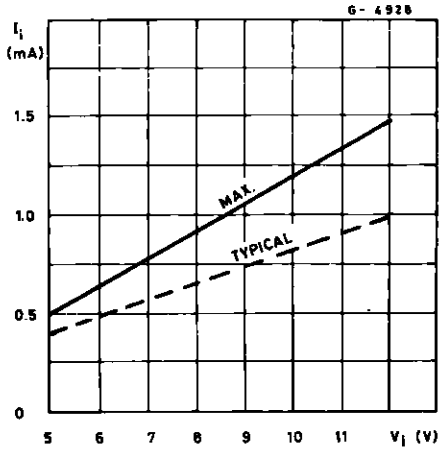

Figure 15 : Input Current as a Function of Input Voltage (for ULQ2803A)

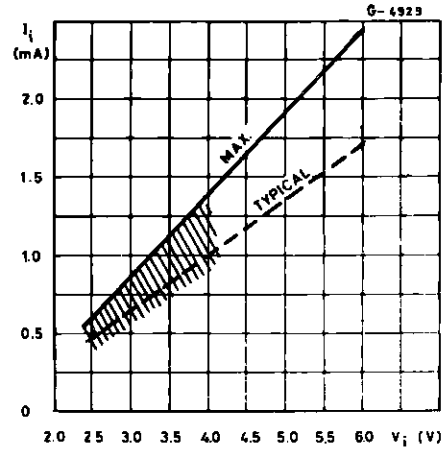
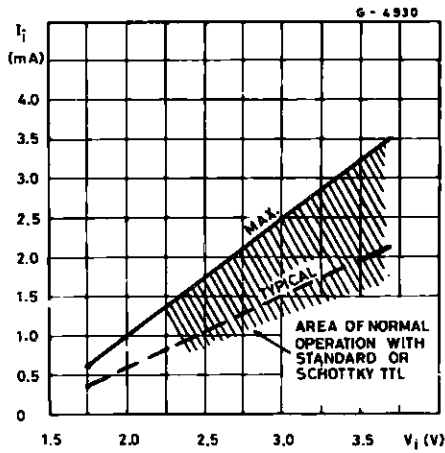

Figure 16 : Input Current as a Function of Input Voltage (for ULQ2805A)



ULQ2801A - ULQ2802A - ULQ2803A - ULQ2804A - ULQ2805A

DIP18 PACKAGE MECHANICAL DATA

DIM.	mm			inch		
	MIN.	TYP.	MAX.	MIN.	TYP.	MAX.
a1	0.254			0.010		
B	1.39		1.65	0.055		0.065
b		0.46			0.018	
b1		0.25			0.010	
D			23.24			0.915
E		8.5			0.335	
e		2.54			0.100	
e3		20.32			0.800	
F			7.1			0.280
l			3.93			0.155
L		3.3			0.130	
Z		1.27	1.59		0.050	0.063

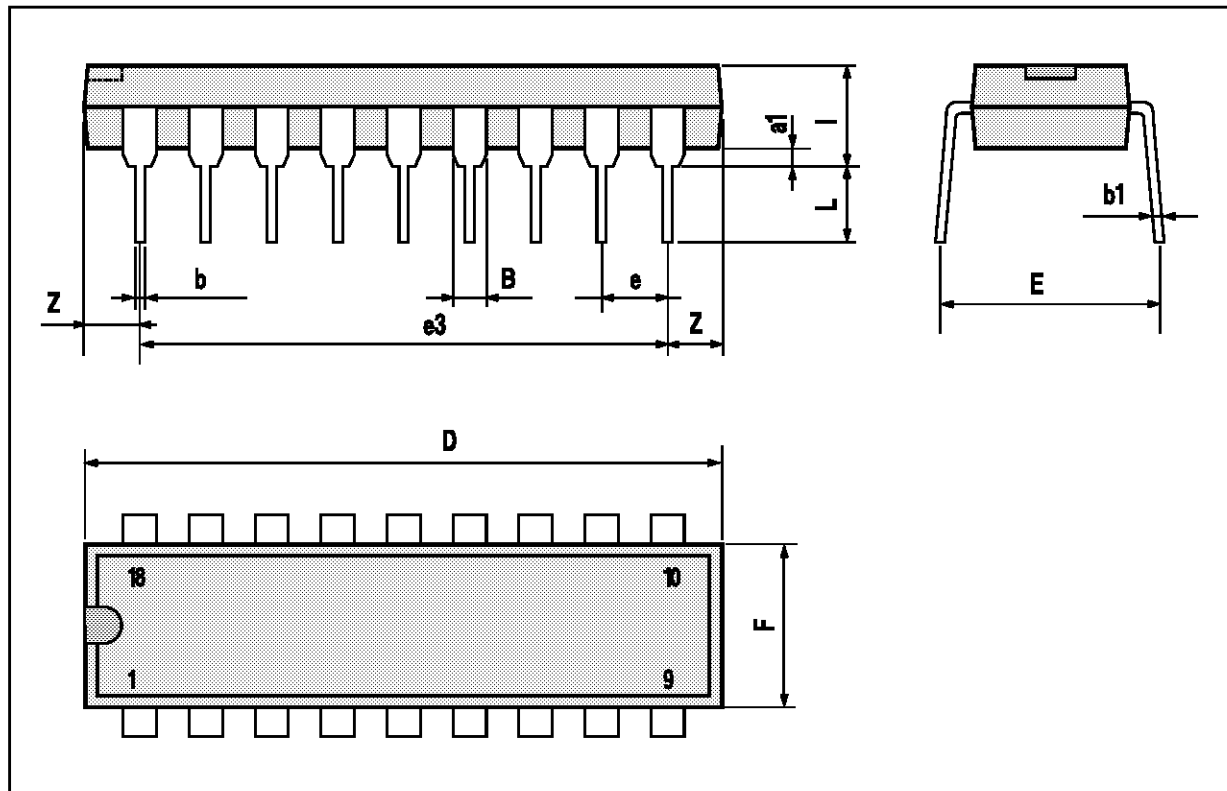

Information furnished is believed to be accurate and reliable. However, SGS-THOMSON Microelectronics assumes no responsibility for the consequences of use of such information nor for any infringement of patents or other rights of third parties which may result from its use. No license is granted by implication or otherwise under any patent or patent rights of SGS-THOMSON Microelectronics. Specifications mentioned in this publication are subject to change without notice. This publication supersedes and replaces all information previously supplied. SGS-THOMSON Microelectronics products are not authorized for use as critical components in life support devices or systems without express written approval of SGS-THOMSON Microelectronics.

© 1994 SGS-THOMSON Microelectronics - All Rights Reserved

SGS-THOMSON Microelectronics GROUP OF COMPANIES

Australia - Brazil - France - Germany - Hong Kong - Italy - Japan - Korea - Malaysia - Malta - Morocco - The Netherlands - Singapore - Spain - Sweden - Switzerland - Taiwan - Thailand - United Kingdom - U.S.A.